



PORSCHE



# 911 Turbo and 911 Turbo S

Coupé and Cabriolet





<b>The 911 Turbo concept</b>	<b>6</b>
Efficiency	8
Technology	12
Design	16
Model range	18
<b>Performance</b>	<b>26</b>
Engine	30
Transmission	42
Chassis	52
<b>Responsibility</b>	<b>62</b>
Safety	64
Environment	74
<b>Personality</b>	<b>78</b>
Comfort	80
Personalisation	90
<b>Service</b>	<b>106</b>
<b>Summary</b>	<b>108</b>
<b>Technical data</b>	<b>110</b>
<b>Index</b>	<b>114</b>



## The 911 Turbo concept

Were those moments when you exercised moderation always the crucial ones?

### The efficiency of the 911 Turbo model concept.

**According to the definition, efficiency is the ratio of work input to work output. If something is highly efficient, it keeps work input low, whilst maximising work output. A principle that unreservedly applies to any 911 Turbo. But not necessarily to the work that went into developing it.**

To understand the evolution of the 911 Turbo, you have to go back to 1974. To France, and the Paris Motor Show. To the first turbocharged 911. The wrong car at the wrong time. At least that's what some journalists, doubters and waverers thought.

Their reservations were entirely understandable. After all, times were hard and oil was in short supply. Then Porsche launched a car that anticipated the concept of the super sports car, with its power output of 260 hp, maximum torque of 343 Nm and 5.5-second sprint from 0 to 100 km/h (62 mph).

What on earth was going on at Zuffenhausen? Was it a lack of understanding of the needs of the market? A blinkered desire for power? Perhaps even over-confidence and a lack of awareness?

Certainly the desire for power could not be denied. But it had a goal. And the way to that goal followed a unique path. A glance at the data sheet was enough. Alongside the fabled engine output, torque, acceleration and top

speed figures were other, no less impressive figures.

A 3-litre displacement and six cylinders in a boxer configuration were all that the first 911 Turbo needed to turn the sports car world (where the motto was 'size equals power') upside down.

In other words, the car on show on the stand in Paris wasn't just a car bursting with power. Here was an idea, an opportunity.

To get more from less. To optimise the ratio of work input to work output. In short, efficiency demands performance. That was the principle. And it still stands to this day.





The car was made technically possible by an invention from 1905. The Swiss engineer, Dr. Büchi, utilised the energy of the flow of exhaust gases to increase the efficiency of combustion engines.

You don't need to be an engineer to understand the practical benefits of this. Turbocharging means a tremendous gain in power for comparatively small engine displacements. The advantage of small-displacement engines is particularly felt in the lower and

middle load ranges – in other words, during everyday driving on the road. In these conditions, fuel consumption and CO<sub>2</sub> emissions figures are significantly lower than those for larger engines.

Another advantage is the compact engine size which reduces weight. The engine takes up less space and keeps the overall vehicle weight down. In short, agility and dynamic performance are increased and fuel consumption is decreased.

Of course, in 1974, the technology was still in its infancy. The idea needed to mature, but the fact remained that it worked. What started out as a scheduled production run of 400 vehicles has become a lifetime's work.

Over the years, alongside continual increases in power output, the 911 Turbo has seen the introduction of a wide variety of technologies to improve handling and dynamic performance as well as fuel consumption and efficiency.

Examples from 1977 include above all the intercooler, which improved turbocharger efficiency, and the cross-drilled brake discs, which increased braking performance and reduced unsprung masses. In 1990, the 911 Turbo based on the Type 964 was the first to be equipped with a regulated catalytic converter as standard.

The twin-turbo engine introduced in 1995 performed excellently, delivering a significantly more

harmonious build-up of power and making the 911 Turbo a much more composed and thereby more fuel-efficient vehicle. All-wheel drive was introduced for the first time, increasing both traction and safety.

A major step towards greater efficiency was achieved in 2000 with the launch of the 911 Turbo based on the Type 996. This saw the use of technologies that are also to be found on the latest 911 Turbo generation. VarioCam Plus reduced fuel consumption drastically, whilst the extending rear wing, through its ability to change position, complemented the already exemplary aerodynamic performance.

In 2006, the launch of the 911 Turbo based on the Type 997 revealed a revolution in turbocharging, with the advent of Variable Turbine Geometry (VTG). More power. More torque. Less fuel. Less CO<sub>2</sub>. Porsche was the first car manufacturer that was able to use this technology in standard-production petrol engines. And so far is the only one to do so.

And today? The principle behind the 911 Turbo is still one of power and efficiency and consequently is just as valid as ever.

Direct fuel injection (DFI) improves power output, torque and engine response whilst also reducing fuel consumption and CO<sub>2</sub> emissions. The Porsche Doppelkupplung (PDK), or double-clutch gearbox, shortens gearshift times, eliminates any interruption in the flow of power and increases efficiency thanks to the long-ratioed 7th gear. Also doing their bit are the expansion intake manifold and on-demand oil pump.

Let's get down to the details.

**Dreamers. Idealists. Environmental activists.  
We are naturally proud of our engineers.**

### The technology behind the 911 Turbo and the new 911 Turbo S models.

**The development of a 911 Turbo demands meticulous work. Often, that work goes unseen. But you always feel it.**

Let's start right at the beginning. Or should we say, at the rear. With the engine – the all-important heart of any 911 Turbo model. The performance credentials of the compact, lightweight power unit need no questioning. All models have an engine displacement of 3.8 litres. In the 911 Turbo models, the engine generates 368 kW (500 hp) and 650 Nm of torque. In the new 911 Turbo S models, these figures are an even more impressive 390 kW (530 hp) and 700 Nm, made possible by a modified valve control system and an adaptation of the engine management.

Responsible for such high efficiency are the two exhaust gas turbochargers with Variable Turbine Geometry (VTG) and VarioCam Plus as well as technologies such as direct fuel injection (DFI, page 32) and the expansion intake manifold (page 40), which has turned all previous principles about air supply for turbocharged engines completely on their heads.

With DFI, mixture formation takes place entirely in the combustion chamber. The metered fuel is injected directly with millisecond precision. The result is optimum mixture formation and combustion and consequently more power, more torque and increased efficiency. Depending on the model, fuel savings of up to 16% and reductions in CO<sub>2</sub> emissions of up to 18% can be achieved (by comparison with the previous 911 Turbo generation).

Porsche Doppelkupplung (PDK, page 42), fitted as standard to 911 Turbo S models and available as an option for 911 Turbo models, is based on a Porsche development that caused a sensation on the world's racetracks back in the 1980s when it was fitted into Porsche race cars.

PDK, with both manual shift and automatic mode, has two half-gearboxes incorporated into one housing and a total of seven forward gears and two clutches.



911 Turbo

Gear-changing is completed in a matter of milliseconds, with no interruption in the flow of power. Compared with a conventional manual gearbox, PDK significantly improves acceleration whilst reducing fuel consumption. In comparison with the automatic gearbox in the previous model, PDK delivers even more driving pleasure through increased responsiveness and thus greater

agility, but with no loss of comfort and a significant reduction in fuel consumption. In conjunction with PDK, the three-spoke sports steering wheel with gearshift paddles comes as standard on 911 Turbo S models and is available on request for 911 Turbo models.

The further-enhanced active all-wheel drive system, Porsche

Traction Management (PTM, page 48), ensures outstanding traction and vehicle dynamics. Giving dynamic performance a further boost is Porsche Torque Vectoring (PTV, page 50). Standard on 911 Turbo S models and optional for 911 Turbo models, it distributes variable amounts of drive torque to each rear wheel.

Porsche Stability Management (PSM, page 56) and Porsche Active Suspension Management (PASM, page 53) are standard across the 911 Turbo model range. The Porsche Ceramic Composite Brake (PCCB, page 68) is fitted as standard exclusively on 911 Turbo S models.

Standard on 911 Turbo S and optional on 911 Turbo models is the Sport Chrono Package Turbo with dynamic engine mount system (page 58). It has a whole host of performance-enhancing functions. The 'overboost' on 911 Turbo models, for example, briefly raises boost pressure when accelerating in the lower and mid-engine speed ranges to provide an additional 50 Nm of torque. On 911 Turbo S models, the permanently increased maximum boost pressure guarantees that a maximum torque of 700 Nm is available for an unlimited period.

When combined with PDK, the SPORT PLUS button can activate 'Launch Control', for optimum

acceleration from a standing start, or the motorsport-derived gearshift strategy for racing-style gear changes. The dynamic engine mount system improves ride comfort and vehicle dynamics whilst also providing more stable handling. The system reduces the oscillations and movements of inert masses in the drive assembly by automatically changing the stiffness and damping characteristics of the engine mounts.

As is so typical of the 911 Turbo, comfort and sound are not neglected either. Porsche Communication Management (PCM, page 86), including a navigation module and 6.5-inch touchscreen, and the BOSE® Surround Sound System both come as standard. The standard specification of the 911 Turbo S models gives you even more, such as the integrated six-disc CD/DVD autochanger, adaptive sports seats and cruise control.

It sounds, therefore, as though the 911 Turbo model range has

got it all. Apart from weight, that is. The doors and bonnet are made of aluminium and the engine is particularly lightweight thanks to the use of light alloys and integral dry-sump lubrication. Forged 19-inch 911 Turbo II wheels

on the 911 Turbo models and forged 19-inch RS Spyder wheels with a central locking device on the 911 Turbo S models keep the unsprung masses low. The result is a power-to-weight ratio of 3.1 kg/hp for the Coupé and

3.3 kg/hp for the Cabriolet (911 Turbo S models: 3.0 kg/hp and 3.1 kg/hp respectively).

The technology of the 911 Turbo and 911 Turbo S models has enabled a balance to be achieved.

It increases power at the same time as maintaining comparatively low fuel consumption figures and CO<sub>2</sub> emissions, showing that, at Porsche, efficiency and power are inseparable.



911 Turbo Cabriolet



**It is precisely in turbulent times when we need a place of calm.**

**Design.**

**Keeping the tried-and-tested without ignoring innovation. Another example of the efficiency of the 911 Turbo.**

The styling is dynamic without being fussy. Sporty without being ostentatious. In short, no gimmicks, no showiness, no doubts.

The side air-intake grilles in the front apron have titanium-coloured painted slats. To the right or left respectively of the grilles are the daytime running lights, positioned low down. Like the indicators, they utilise

LED technology to provide increased illumination and give a characteristic look. Optional dynamic cornering lights are an additional safety feature (standard on 911 Turbo S models).

Glancing over the sides of the 911 Turbo models, you will notice the linear, no-frills twin-spoke design of the 911 Turbo II wheels.

Elements of the spokes and wheel rim have a high-sheen finish. The wheels are forged and the sophisticated technology facilitates a lightweight, yet highly rigid design.

On the 911 Turbo S models, the forged aluminium wheels in the RS Spyder design with a central locking device provide a good glimpse of the yellow brake calipers of the standard Porsche Ceramic Composite Brake (PCCB, page 68).

The rear features LED taillights that extend right round to the wings where they taper to a point. The LED brake lights respond extremely quickly, thereby increasing active safety. In other words, the traffic behind is warned sooner.

The two tailpipes are positioned neatly in the recesses of the rear apron and provide a visual reminder of the engine's increased power.

A characteristic feature of the 911 Turbo is the rear wing, which extends at 120 km/h (75 mph), retracting again when vehicle speed drops to around 60 km/h



(37 mph). The drag coefficient is just 0.31 (Cabriolet models: 0.32).

The interior design is also characteristic: sporty, uncluttered and ergonomically refined. Careful consideration has been given to the interior geometry and there is a generous amount of occupant space. The gear lever design is exclusive to 911 Turbo models

equipped as standard with the manual gearbox. Reserved for 911 Turbo S models is the two-tone leather interior with contrasting seams on the seats, door panels and dashboard.

For more information on the many possible combinations of technological options, colours and materials for the interior, please see page 90 onwards.



Interior of the 911 Turbo in Carrera Red natural leather



Rear wing lowered



Rear wing raised

You don't have to depart this life to become a legend.

### Model range.

**Closed or open, 'S' or no 'S'. There are many ways to interpret the 911 Turbo concept. But one thing remains the same: making a choice never means making a compromise on power and efficiency.**

#### The 911 Turbo.

Although the figures provide succinct proof of its power, there is one value in particular that makes a 911 Turbo what it is: constancy. Of course, much has changed in the course of seven generations, but the basic principle remains the same.

It is in the nature of the 911 Turbo to handle its power effortlessly and with composure. Power is available at all times. The 3.8-litre six-cylinder boxer engine with DFI outputs 368 kW (500 hp) between 6,000 rpm and 6,500 rpm and summons up 650 Nm of torque between 1,950 rpm and 5,000 rpm. Despite delivering

more power than the previous model, it has been possible to reduce fuel consumption and CO<sub>2</sub> emissions significantly, by up to 16% and 18% respectively, depending on the model.

Here are some more fascinating facts: with the standard six-speed manual gearbox, the traditional 0 to 100 km/h (62 mph) sprint is achieved in just 3.7 seconds. With the optional PDK and Sport Chrono Package Turbo with dynamic engine mount system, this time is reduced even further, to 3.4 seconds. The 200 km/h (124 mph) mark is reached in 11.9 and 11.3 seconds respectively. Top speed is 312 km/h (194 mph).

These figures undoubtedly brand the 911 Turbo as a super athlete. Yet the amazing thing is the ease with which the driver can achieve them. Helping to make it all so easy are the standard-fitted Porsche Traction Management (PTM) active all-wheel drive, Porsche Stability Management (PSM), Porsche Active Suspension Management (PASM) and optional Porsche Torque Vectoring (PTV).



911 Turbo

What's also interesting is that these technologies not only produce impressive performance figures, they also vastly improve the car's everyday practicality.

The same can be said for the comfortable interior. Leather trim and the multi-way electrically adjustable comfort seats with driver memory function come as standard. Porsche Communication Management (PCM) with a GPS navigation system features intuitive controls, while the standard

BOSE® Surround Sound System provides an impressive sound experience. Seat ventilation, steering wheel heating and many other personalisation options are available on request.

The 911 Turbo. Whether you perceive it as a no-compromise embodiment of the power principle or as a technology platform that effortlessly combines efficiency with comfort and a sporty edge depends on one thing above all else: your point of view.



911 Turbo with optional 19-inch RS Spyder wheels

### The new 911 Turbo S.

The new 911 Turbo S is perhaps the embodiment of one of the original Porsche principles: to make do is not an option. To stand still is inconceivable. We move on, and more awaits around the corner. Never anxious, always cool and composed. Looking forward at all times. This is why we gave the 911 Turbo S even more.

As a result of a modified valve control system and an adaptation of the engine management, combined with an increase in maximum boost pressure by 0.2 bar to 1.2 bar, the 3.8-litre boxer engine develops 390 kW (530 hp) between 6,250 rpm and 6,750 rpm. The maximum torque is an impressive 700 Nm between 2,100 rpm and 4,250 rpm. This means an extra 30 hp and 50 Nm compared with the 911 Turbo.

Yet, even though power output has been increased, fuel consumption and CO<sub>2</sub> emissions remain at the same low level thanks to the use of efficient technologies such as DFI, Variable Turbine Geometry (VTG), VarioCam Plus and the expansion intake manifold.

Visually, the engine is distinguished by an air filter housing with a carbon-weave finish and the 'turbo S' logo.

The 911 Turbo S models represent power in pure form, and they have the performance figures to prove it. With the standard combination of PDK and the Sport Chrono Package Turbo with dynamic engine mount system, the 911 Turbo S storms through the 100 km/h (62 mph) mark from a standing start in just 3.3 seconds – the fastest ever achieved by a Porsche production car. 0 to 200 km/h (124 mph): 10.8 seconds. Top speed: 315 km/h (196 mph). It has even been possible to improve driving dynamics, thanks not least to the standard-fitted Porsche Torque Vectoring (PTV) including a mechanically locking rear differential.

At Porsche, whenever we provide more power as standard, we naturally include extra safety features as standard, too. The track-proven Porsche Ceramic Composite Brake (PCCB) and the dynamic cornering lights are two examples.

Also fitted as standard are the lightweight, forged RS Spyder wheels with a motorsport-derived central locking device.



Interior of the 911 Turbo S in two-tone leather (Black and Titanium Blue)

Inside, the three-spoke sports steering wheel with gearshift paddles is pleasing to the eye, and to the touch. The gearshift logic comes straight from the racetrack: pull the right-hand paddle to shift up, pull the left-hand paddle to shift down. Other standard features include the adaptive sports seats, the six-disc CD/DVD autochanger integrated into the PCM, cruise control, the choice of two-tone leather interior in Black and Cream or Black and Titanium Blue exclusive to the 911 Turbo S

models, and the windscreen with a grey top-tint.

Visual cues that hint at the enormous power within are the 'turbo S' logos on the door sill guards, rev counter, rear lid and plaque on the upper section of the air cleaner.

The new 911 Turbo S. The most powerful interpretation of the 911 Turbo concept there has ever been. Charged with a passion to surpass past achievements. Again and again.



911 Turbo S



911 Turbo S Cabriolet

**The 911 Turbo Cabriolet and the new 911 Turbo S Cabriolet.**

If life is a journey, wouldn't it be a tragedy not to enjoy it to the full? Perhaps it's this – admittedly somewhat philosophical – outlook that best explains the desire for an open-top 911 Turbo.

It's all about that intense experience of driving with the hood down. Coupled with the impressive

way in which the 3.8-litre boxer engines unleash their power. Their performance figures are identical to those of the Coupés. Whether you choose 500 hp or 530 hp will depend on how much value you place on engine power. Both models have a drag coefficient of 0.32 when the hood is closed.

When fitted with the manual gearbox, the 911 Turbo Cabriolet

(62 mph) in just 3.8 seconds. With PDK and the Sport Chrono Package Turbo with dynamic engine mount system (standard on the 911 Turbo S Cabriolet), it takes even less time, just 3.5 seconds. Top speed is 312 km/h (194 mph). The 911 Turbo S Cabriolet, equipped with PDK as standard, demolishes the 100 km/h (62 mph) barrier in 3.4 seconds and has a top speed of 315 km/h (196 mph).

Besides the equipment that you would normally expect to find on a convertible car, the 911 Turbo Cabriolet and 911 Turbo S Cabriolet have the same standard specification as their Coupé counterparts.

To prevent body flexing as much as possible, the body is designed for high torsional and flexural strength. As a result you get the same precise, direct driving experience as you do in the Coupé

models. Despite the slightly heavier weight, fuel consumption is comparable with that of the Coupés.

The dynamic engine mount system of the Sport Chrono Package Turbo (standard on the 911 Turbo S Cabriolet) reduces oscillations and vibrations and further improves ride comfort.

Where safety is concerned too, the Cabriolet models meet the most stringent requirements. These, too, have full-size airbags for driver and passenger as well as Porsche Side Impact Protection (POSIP, page 72). The safety package is supplemented by the effective roll-over system (page 72) and reinforced A-pillars.



Interior of the 911 Turbo S Cabriolet in two-tone leather (Black and Cream)

### Hood.

The fully automatic fabric hood is lightweight and robust. It saves weight in just the right place and keeps the centre of gravity low. When stowed, the hood requires significantly less space than a folding hardtop. The glass rear screen is scratch-resistant and heated – to provide excellent rearward visibility. A rain channel on the hood reduces dripping when the doors are opened.

Electrically powered, the hood is opened using a button on the centre console or via the key remote.

The concertina action ensures optimum protection for the interior lining. The entire operation – be it opening or closing – takes approximately 20 seconds. For added convenience, the hood can be operated while the vehicle is travelling at speeds of up to 50 km/h (31 mph).

The interior hood lining is made from a sound and heat-insulating fabric. The resulting noise levels are astonishingly low, even when travelling at high speed. Ensuring you hear almost nothing – apart from that typical Porsche sound.



Wind deflector

### Wind deflector.

The 911 Turbo Cabriolet and the 911 Turbo S Cabriolet come with a detachable wind deflector as standard. Developed in the Porsche wind tunnel, it reduces turbulence and noise at high speed. It is easy to fit and can be folded and stowed in the luggage compartment.

### Hardtop.

Optional equipment includes a tough and lightweight aluminium hardtop which is also easy to fit. The interior is lined with a sound-absorbent fabric that complements the passenger compartment.





## Performance



- |                            |                                    |
|----------------------------|------------------------------------|
| 1. Radiator module (left)  | 8. Expansion intake manifold       |
| 2. Radiator module (right) | 9. Exhaust system                  |
| 3. Coolant pipe            | 10. Tank                           |
| 4. Coolant expansion tank  | 11. 7-speed Porsche Doppelkupplung |
| 5. Air filter              | 12. Tandem brake booster           |
| 6. Intercoolers            | 13. Spring struts with PASM damper |
| 7. Pressure pipe           | 14. Steering column                |

**Handling pressure demands composure.  
Another example of why things are done a little bit differently at Porsche.**

## Engine.



Engine with intercooler

The 911 Turbo models generate 368 kW (500 hp) between 6,000 rpm and 6,500 rpm and 650 Nm of torque between 1,950 rpm and 5,000 rpm (700 Nm for a temporary period with the 'overboost' of the optional Sport Chrono Package Turbo with dynamic engine mount system).

In the 911 Turbo S models, a modified valve control system and an adaptation of the engine management, combined with an increase in maximum boost pressure by around 0.2 bar, enable the power unit to produce 390 kW (530 hp) between 6,250 rpm and 6,750 rpm and generate a permanently high torque of 700 Nm between 2,100 rpm and 4,250 rpm to deliver even more power to the road.

The consistently high low-end torque of both engine variants means that you can relax behind the wheel – and relax about fuel consumption, too.

Fuel consumption is a consideration that at present is becoming at least as important as performance figures. Including – perhaps particularly – for sportscars of this genre. Despite the increase in power, the 911 Turbo with the standard six-speed manual gearbox uses 9% less fuel than the previous model. It has been possible to reduce CO<sub>2</sub> emissions by up to 11%. The fuel consumption

and emissions of the 911 Turbo S models are as low as those of the 911 Turbo models, despite 30 hp of extra power output. Both engine variants comply with the Euro 5 emissions standard.

This has required the use of sophisticated technologies and processes. Examples include direct fuel injection (DFI), VarioCam Plus, Variable Turbine

Geometry (VTG) and the expansion intake manifold.

On balance, the engines of the 911 Turbo and 911 Turbo S models demonstrate power, even when it's not just about power in the traditional sense of the word. The following pages of the Performance chapter are dedicated to this concept.

**The power concept of 1974: a rear-mounted turbo-charged engine. The efficiency concept of today: DFI, VarioCam Plus and Variable Turbine Geometry.**

The location of the six-cylinder boxer engine was not up for discussion. Neither was the use of two exhaust gas turbochargers with Variable Turbine Geometry (VTG). These are permanent fixtures in a successful concept. But that was no reason for Porsche engineers to rest on their laurels.

As a result, the 3.8-litre flat-six engine now comes in two power levels.







### Direct fuel injection (DFI).

On the 911 Turbo models, DFI injects the fuel with millisecond precision directly into the combustion chamber at up to 140 bar via electromagnetically actuated injection valves, thus ensuring

homogeneous distribution of the air/fuel mixture and consequently efficient combustion.

In the direct injection system, the EMS SDI 3.1 engine management system adjusts the injection timing individually for each

cylinder and the injection quantity for each cylinder bank. This optimises both the combustion curve and fuel consumption.

Dual injection is implemented at engine speeds of up to 3,200 rpm and triple injection

up to 2,700 rpm to ensure faster catalyst warm up after a cold start and more torque in the upper load range. The required quantity of fuel is distributed to two or three successive injection processes per cycle.

DFI improves the internal cooling of the combustion chamber by forming the mixture directly in the cylinder. This has made it possible to increase compression (9.8:1), resulting in more engine power and even greater efficiency.

### Integrated dry-sump lubrication.

Integrated dry-sump lubrication ensures a reliable supply of oil even when a sporty driving style is adopted. It also has additional cooling functions.

The oil tank is located in the engine, thereby eliminating the need for an external oil tank.

A total of seven oil pumps ensure the supply of oil. Six of those return the oil from the cylinder heads and exhaust gas turbochargers directly to the oil sump where a seventh oil pump feeds oil directly to the lubrication points in the engine.

To reduce drive losses and increase efficiency, an electronic on-demand oil pump is used. This means that the oil pump is operated at high power when there is high demand and at low power when there is low demand. The result is an optimised oil supply appropriate to requirements, lower fuel consumption and fewer emissions.



Engine with air filter housing with a carbon-weave finish in the new 911 Turbo S models

**Lightweight design.**

An alloy engine means less weight and consequently reduced fuel consumption. The intelligent engine design also saves weight.

The alloy crankcase is divided vertically, with the cylinders integrated into the crankcase. Forged connecting rods are used.

For optimum durability, we've used forged aluminium pistons running in cylinders made from an aluminium/silicon alloy and cooled via individual oil-spray jets.

Integrating the camshaft bearing system fully into the cylinder heads has also saved weight. The subsequent low levels of engine friction and the efficient design of

the oil supply system have helped to reduce fuel consumption even further.

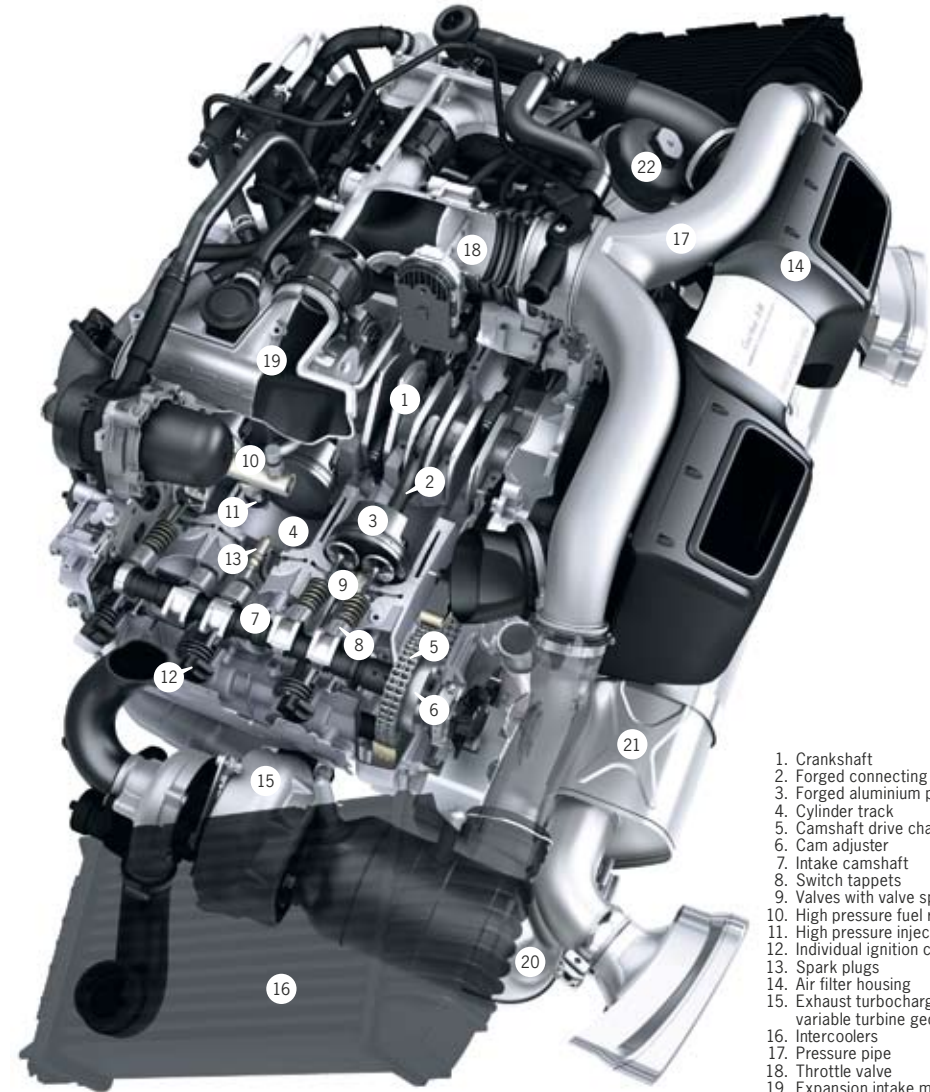

1. Crankshaft
2. Forged connecting rods
3. Forged aluminium pistons
4. Cylinder track
5. Camshaft drive chain
6. Cam adjuster
7. Intake camshaft
8. Switch tappets
9. Valves with valve springs
10. High pressure fuel rail
11. High pressure injectors
12. Individual ignition coils
13. Spark plugs
14. Air filter housing
15. Exhaust turbocharger with variable turbine geometry
16. Intercoolers
17. Pressure pipe
18. Throttle valve
19. Expansion intake manifold
20. Catalytic converters
21. Exhaust system
22. Oil filter

**Variable Turbine Geometry (VTG).**

The 911 Turbo and 911 Turbo S models are straightforward, almost matter-of-fact, when it comes to handling power. VTG has contributed enormously to this.

The variable turbine geometry of the twin water-cooled exhaust gas turbochargers goes a long way to resolving the conflict of aims of normal turbochargers. With this technology, the gas flow from the engine is channelled onto the turbines via electronically adjustable guide vanes. By changing the vane angle, the system can

replicate the geometry in all types of turbo, large or small, and thus achieve the optimum gas-flow characteristics. The guide vanes are controlled by the engine management system.

The result is a high turbine speed – and therefore higher boost pressure – even at low engine rpm. With more air available, the combustion is increased, yielding greater power and torque. Maximum torque is reached at lower rpm and is retained across a wider rev range. Both engine variants deliver a torque of just 650 Nm from as low as 1,950 rpm. In the case of the 911 Turbo

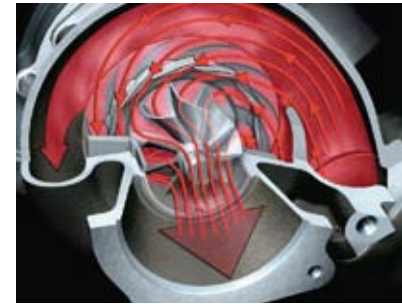

Guide vanes closed

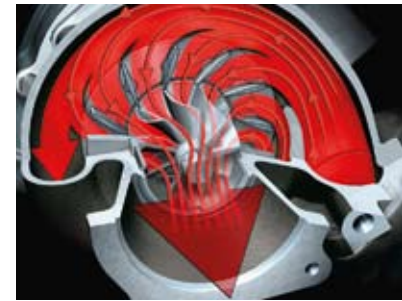

Guide vanes open

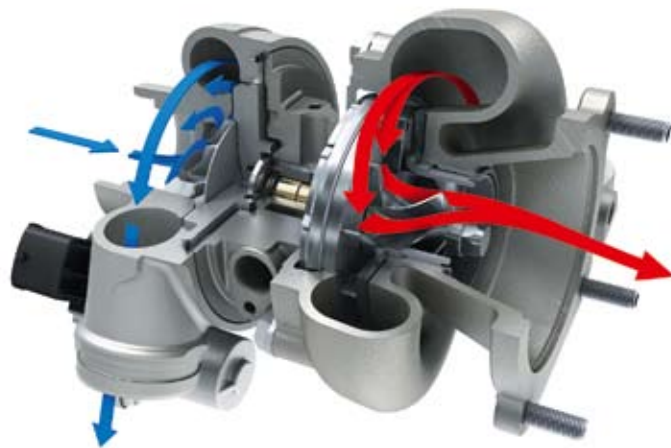

Variable Turbine Geometry (VTG)

models, this torque is available up to 5,000 rpm. The increased maximum torque of 700 Nm in the 911 Turbo S models is available between 2,100 rpm and 4,250 rpm.

When the boost pressure reaches its maximum value, the guide vanes are opened further. By varying the vane angle, it is possible to achieve the required boost

pressure over the entire engine speed range. As a result, there is no need for excess-pressure valves as found on conventional turbocharged engines.

In the 911 Turbo models, engine performance can be further enhanced by selecting the SPORT button on the optional Sport Chrono Package Turbo. Under full acceleration, the maximum

boost pressure in the lower and medium speed ranges is temporarily increased by approximately 0.2 bar. As a result, engine torque is temporarily boosted by 50 Nm to a maximum of 700 Nm. The 911 Turbo S models, by contrast, are configured to operate with a higher boost pressure level, which means that their maximum torque of 700 Nm is available for an unlimited period.

These values are sure to impress. Yet, combined with the fuel economy achieved despite the high power output, they are even more impressive. Because power alone is not enough.

**VarioCam Plus.**

VarioCam Plus is a variable valve timing system on the inlet side which also features two-stage valve lift. For excellent smooth-running performance, better fuel economy and fewer emissions. And greater power and torque.

The timing of each valve is steplessly and electro-hydraulically controlled by means of a rotary vane adjuster.

For optimum responsiveness during the warm-up phase, VarioCam Plus will select the higher valve lift setting and retard valve timing. At medium revs and low engine loads, the lower valve lift setting is selected and timing advanced in order to reduce fuel consumption and emissions. For maximum power and torque, the higher lift setting is selected and the timing of the valves is advanced.



VarioCam Plus

**Engine management.**

The EMS SDI 3.1 engine management system ensures optimum performance at all times.

It is responsible for all engine-related functions and assemblies, resulting in improved fuel economy, emission levels and performance, regardless of driving style.

Another important task performed by the engine management system is cylinder-specific knock control. Since conditions tend to vary across the engine, each cylinder is monitored separately. If a risk is detected, the individual ignition timing is adjusted to protect the cylinders and pistons at high engine speeds and loads. The EU-compliant on-board diagnostics system provides continuous fault detection as well

as early warning for the exhaust and fuel supply systems. This actively reduces harmful emissions while maintaining consistent rates of fuel consumption.

**Ignition system.**

The ignition system is a static high-voltage system. Each individual spark plug has a separate ignition coil, ensuring perfect combustion every time.

**Expansion intake manifold.**

More power for less fuel. What sounds absurd is sometimes quite simple. You just have to have the nerve to question principles that are seemingly written in stone.

The 911 Turbo and 911 Turbo S models have an innovative expansion intake manifold that was used for the first time on the latest 911 GT2. Its unique operating principle is unlike anything ever featured on existing induction systems. Our 'expansion' intake manifold is a radical development that is the polar opposite of the resonance principle used on conventional turbocharged engines.

A resonance manifold increases engine output by forcing additional air into the combustion chambers. To do this, the manifold is designed in such a way that the air – which vibrates due to the action of the valves – is in a compression phase as it passes through the inlet ports.

Unfortunately, compression not only increases air volume, it also increases air temperature and this has a negative effect on ignition.

Our expansion manifold simply turns that principle around. The internal geometry is radically different from that on a resonance intake system. Key modifications include a longer distributor pipe, with a smaller diameter, and shorter intake pipes. As a result, the air is in the expansion phase as it enters the combustion chambers. Since expansion always cools, the air/fuel temperature is lower and ignition is significantly improved – thereby increasing performance.

Of course, the amount of air that enters the engine under expansion is less than it would be under compression. To compensate for this, we've simply increased the boost pressure. The resulting increase in temperature – again through compression – is immediately offset by the uprated inter-coolers.

Instead of hot compressed air entering the combustion chambers, we now have cooler air generating more power and torque. As a consequence, there is a major improvement in engine efficiency and therefore lower fuel consumption even under heavy loads and at high revs.

As we said, sometimes you just have to question established ideas.



911 Turbo engine and exhaust system

**Exhaust system.**

The exhaust system is made from stainless steel. Its catalytic converters are extremely heat-resistant, yet quick to reach temperature – and thus optimum performance – when the engine is started from cold.

Advanced exhaust gas technology ensures compliance with stringent emissions standards, e.g. Euro 5 in EU markets, LEV II/LEV in the USA.

**Servicing.**

The 911 Turbo and 911 Turbo S models are designed for a long life. A self-adjusting belt drives the generator, power-steering pump and air-conditioning compressor. Valve clearances are adjusted hydraulically, thus avoiding the need for any adjustment work. The camshafts are driven by timing chains that require no maintenance and the ignition system, with the exception of the spark plugs, is also mainte-

nance-free. The cars come with a two-year unlimited mileage warranty.

The long service intervals (see separate price list) keep costs and labour times down and save resources, since fewer service products and consumable parts are used.

**Calm. Storm. Which way round is up to you.**

## Transmission.

**The principle is simple: the transmission ensures that the extraordinary engine power isn't manifested as a blaze of noise and smoke. Unless that's what you really want.**

### Porsche Doppelkupplung (PDK).

Derived from motorsport, PDK, which is standard for 911 Turbo S models and optional for 911 Turbo models, achieves one thing above all else: it provides the perfect balance between uncompromisingly dynamic performance

and exceptional levels of comfort. It's purely about point of view. The driver's especially.

PDK, with both a manual and an automatic mode, enables extremely fast gear changes with no interruption in the power flow. For improved acceleration and

significantly lower fuel consumption – without having to dispense with the advantages of an automatic.

The driver experiences a sportier, even more dynamic drive with more agility. Depending on driving style, gear changes range from exceptionally comfortable to exceptionally sporty.

Manual gear changes are performed using PDK's ergonomically designed gear lever or alternatively, on the 911 Turbo models, using the switches on the three-spoke sports steering wheel: nudge forwards to change up, pull back to change down. Fitted as standard on 911 Turbo S models and available as an option for 911 Turbo models is the three-spoke sports steering wheel with gearshift paddles, which is also capable of operating PDK. With its motorsport-derived gearshift logic, you pull the right-hand paddle to shift up and pull the left-hand paddle to shift down.

PDK has been specially tuned to the characteristics of the 911 Turbo models and the new 911 Turbo S models. It has seven

gears at its disposal. Gears 1 to 6 have a sports ratio, with the top speed being reached in 6th gear. The 7th gear has a long ratio and helps to reduce fuel consumption even further.

PDK is essentially two half-gearboxes in one and thus requires two clutches – designed as a double wet clutch transmission.



Power flow in 1st gear

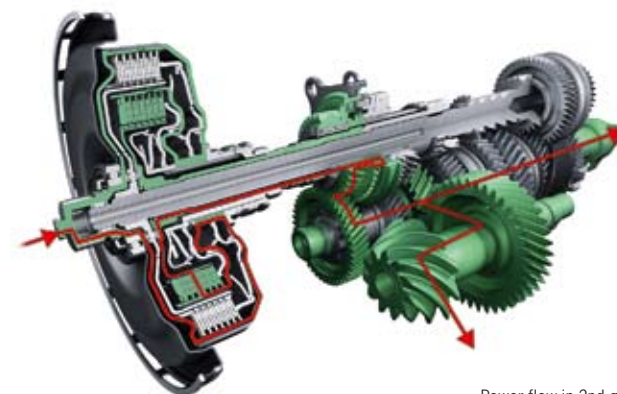

Power flow in 2nd gear



Porsche Doppelkupplung (PDK) gear selector

This double clutch provides an alternating, non positive connection between the two half-gearboxes and the engine by means of two separate input shafts (input shaft 1 is nested inside the hollowed-out input shaft 2).

The flow of power from the engine is only ever transmitted through one half-gearbox and one clutch at a time, while the next gear is preselected in the second half-gearbox. During a gear change, therefore, a conventional shift no longer takes place. Instead, one clutch simply opens and the other closes at the same time. Gear changes can therefore take place within milliseconds.

Clutch 1 controls the first half-gearbox, which contains the odd gears (1, 3, 5, 7) and reverse. Clutch 2 controls the second, which contains the even gears (2, 4, 6).

The Sport Chrono Package Turbo with dynamic engine mount

system (standard on 911 Turbo S models) provides PDK with two additional functions, 'Launch Control' and 'motor sport-derived gearshift strategy' (page 60). PDK – sporty, comfortable and efficient. Characteristics that have been given some thought elsewhere too: in the specification for the 911 Turbo model range.

### **Three-spoke sports steering wheel with gearshift switches.**

If combined with the optional PDK, the three-spoke sports steering wheel (standard on 911 Turbo and 911 Turbo Cabriolet) has two ergonomic switches.

One press with the thumb and PDK shifts up. One pull with the index finger and PDK shifts down. Either the right or left hand can be used.

The steering wheel rim and airbag module are covered in smooth leather, whilst the spoke covers are painted in Black.

When combined with the Sport Chrono Package Turbo with dynamic engine mount system, there is an additional display above the airbag module. It tells you whether the SPORT, SPORT PLUS and Launch Control functions are activated.

On request, the three-spoke sports steering wheel with gearshift switches for the 911 Turbo and 911 Turbo S models is also available as a multifunction steering wheel (in leather, Aluminium Look, carbon or macassar). Steering wheel heating is available as an option.

### **Three-spoke sports steering wheel with gearshift paddles.**

The three-spoke sports steering wheel with gearshift paddles (standard on 911 Turbo S models, optional for 911 Turbo models) allows you to make motorsport-style gear changes. The paddles are made from a strong alloy and are ergonomically located behind

the right and left steering wheel spokes. Pull the right-hand paddle and PDK shifts up. Pull the left-hand paddle and the PDK shifts down.

Visually, the steering wheel is distinguished by its distinctive high-quality twin-spoke design and silver-coloured galvanised spoke cover. The airbag module is finished in the same colour as the steering wheel rim.

This steering wheel also has an additional display when combined with the Sport Chrono Package Turbo with dynamic engine mount system. Located in the left and right-hand steering wheel spokes, it tells you whether SPORT, SPORT PLUS and Launch Control are activated.

Another feature reminiscent of the world of motorsport is the top centre marking on the steering wheel rim.



Three-spoke sports steering wheel with gearshift switches



Three-spoke sports steering wheel with gearshift paddles

**Six-speed manual gearbox.**

The six-speed manual gearbox, available as standard exclusively for the 911 Turbo models, is specifically adapted to the unique characteristics and extremely high torque of the engine in these vehicles. Designed primarily for sports driving, it features a

perfect ratio spread enabling a smooth transition through the gears. The gear lever throw is short and precise, with only minimal effort required. Thanks to a dual-mass flywheel, this performance is achieved without any compromise in comfort.

The linkage provides a direct connection with the gearbox unit while insulating the lever from engine vibration.

One final detail – the gear lever design is exclusive to the 911 Turbo models.

**Hill-start assist.**

Hill-start assist comes as standard for both manual and PDK transmissions. It assists the driver in making a smooth and roll-free start on an incline.

After braking, the system automatically detects whether the

vehicle has come to a stop on a hill. When the driver releases the footbrake with the car still in gear, the brake pressure is retained on all four wheels for around two more seconds. This temporarily prevents the vehicle from rolling backwards. When the driver accelerates (or accelerates and releases the clutch in the case

of manual models), the brake pressure is reduced once sufficient revs have been generated.



Gear lever





### Porsche Traction Management (PTM).

Genuine high performance calls for more than just a powerful engine. It also requires an effective means of delivering that power to the road. One solution to this is all-wheel drive. An even better one is the further-enhanced Porsche Traction Management (PTM), consisting of active all-wheel drive with electronically controlled multi-plate clutch and including an automatic brake differential (ABD) and anti-slip regulation (ASR).

PTM improves vehicle dynamics even further whilst ensuring that none of the customary traction and driving safety is lost. The result is an even more enjoyable sporty ride combined with exceptional stability.

Torque is distributed actively – and exceptionally quickly – via an electronically controlled multi-plate clutch.

The advantage is that, through continuous monitoring of the driving conditions, a more immediate response to changing scenarios can be achieved. The status is monitored with the aid of on-board sensors. These are used to measure a range of values, including the rotational speed of all four wheels, the lateral and longitudinal acceleration of the car, and the current steering angle. The sensor data is analysed in 'real time', enabling immediate adjustments in front-end drive torque as and when required. If, for example, the rear wheels lose traction under acceleration, a greater proportion of drive torque is automatically transmitted to the front axle. At the same time, ASR prevents the rear wheels from spinning by adapting the engine power. When cornering, the system controls drive to the front wheels in order to maintain optimum lateral grip. On variable-grip surfaces, traction is enhanced using the automatic brake differential (ABD). If a wheel

threatens to spin, PTM brakes it via ABD and in doing so transfers more drive torque to the other wheel on the same axle.

Assisting PTM is Porsche Stability Management (PSM). Combined, these systems provide excellent torque distribution – and there-

fore outstanding performance – in all driving conditions.

The benefits of PTM are most evident in wet and snowy conditions. In these conditions, the 911 Turbo models offer breathtaking acceleration.

In short, PTM provides greater active safety and greater performance, combined with exemplary balance.

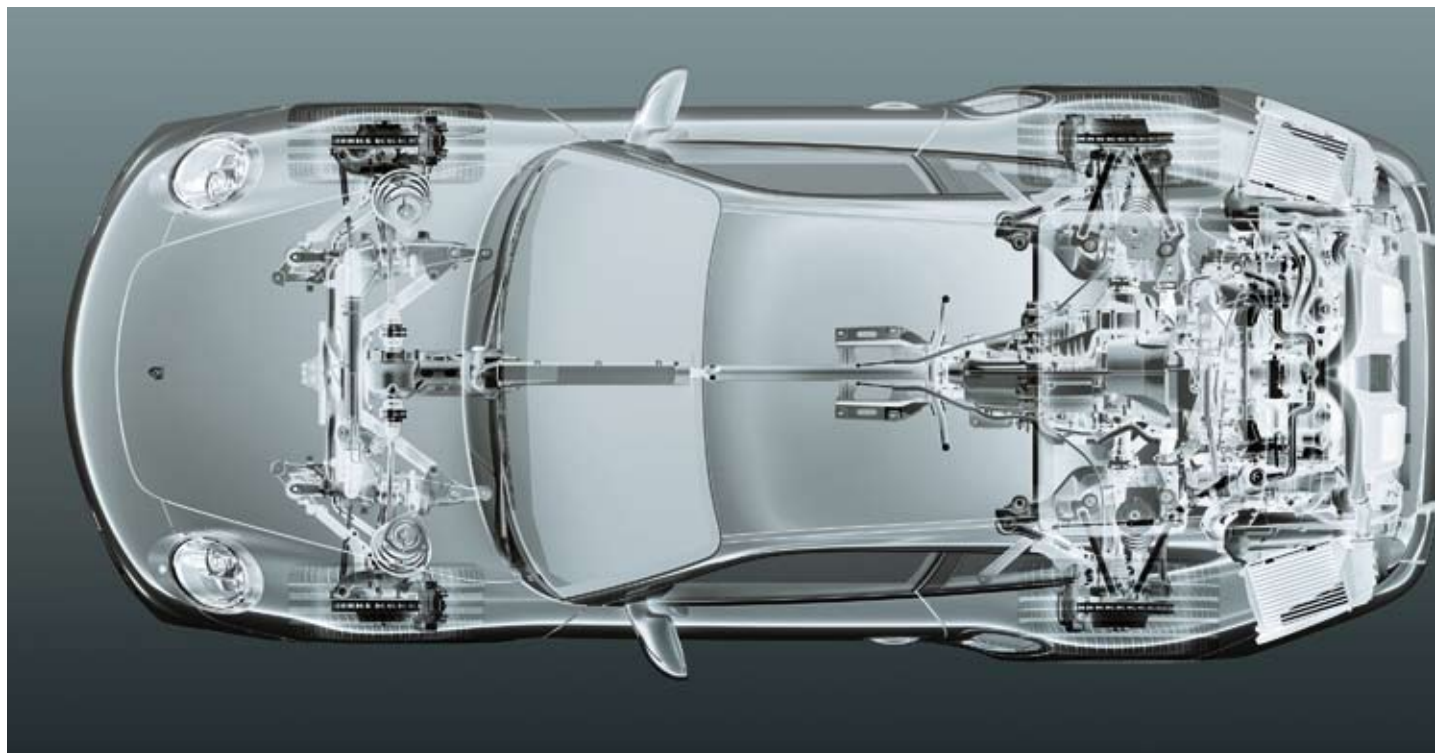

Active all-wheel drive

**Porsche Torque Vectoring (PTV).**

Porsche Torque Vectoring (standard on 911 Turbo S models, optional for 911 Turbo models),

with variable torque distribution to the rear wheels and a mechanical limited-slip rear differential, is a system that actively enhances vehicle dynamics and stability.

As a function of steering angle and steering speed, accelerator pedal position, yaw rate and vehicle speed, PTV is able to improve steering response and

steering precision significantly by specific braking of the right or left rear wheel.

In simple terms, this means that when the car is driven assertively into a corner, moderate brake pressure is applied to the inside rear wheel. Consequently, excess drive force, which varies depending on the braking force applied to the inside rear wheel, can be distributed to the outside rear wheel, and a rotational pulse (yaw movement) is generated around the vehicle's vertical axis. This assists the steering input and results in a more assured steering manoeuvre.

At low and medium vehicle speeds, the system significantly increases agility and steering precision, whilst at high speeds, and in combination with the mechanical limited-slip differential, it additionally ensures greater driving stability.

The system, combined with Porsche Traction Management (PTM) and Porsche Stability Management (PSM), also puts its stabilising effect to good use on road surfaces with varying levels of grip and on snow and ice.

As PTV increases the car's dynamic performance, the system remains active when driving on the racetrack, even if PSM has been deactivated.

Where efficiency is concerned, this enhanced performance and stability are achieved without the need for any additional components, apart from the mechanical limited-slip rear differential. In other words, a more enjoyable drive with no additional weight.



## What's the advantage of being well-balanced? Not letting the smallest thing bother you.

### Chassis.

**Perhaps the most efficient way of overcoming everyday obstacles is to rely on one's own experience. No one knows that better than our own chassis engineers.**

The independent front suspension combines McPherson-type struts with longitudinal and transverse links. Each front wheel is precisely located, ensuring excellent handling and directional stability.

Proven in motorsport, the rear axle assembly features multi-link LSA (Lightweight, Stable, Agile) subframe-based suspension. Its lightweight construction offers excellent dynamic properties. The axle kinematics improves stability under acceleration by reducing

excessive compression. The lightweight strut has an aluminium damper instead of conventional steel to help improve handling and agility.

The resulting suspension enables smooth high-speed manoeuvres in all road and track scenarios. Pitch and roll are reduced to a minimum, as are tyre noise and vibration. The car offers exceptionally high levels of stability.

### **Porsche Active Suspension Management (PASM).**

Included as standard equipment, Porsche Active Suspension Management (PASM) is an electronic active damping system. It offers continuous adjustment of the damping force on each wheel, based on current road conditions and driving style.

At the press of a button, the driver can choose between two

modes. While 'Normal' mode provides a blend of performance and comfort, the 'Sport' setup mode has a much firmer range of settings. The system responds to changing road conditions and/or driving style by continuously varying the individual damping forces within the parameters defined for the selected setup mode ('Normal' or 'Sport'). Pitch and roll are reduced, whilst contact of each wheel with the road is optimised.

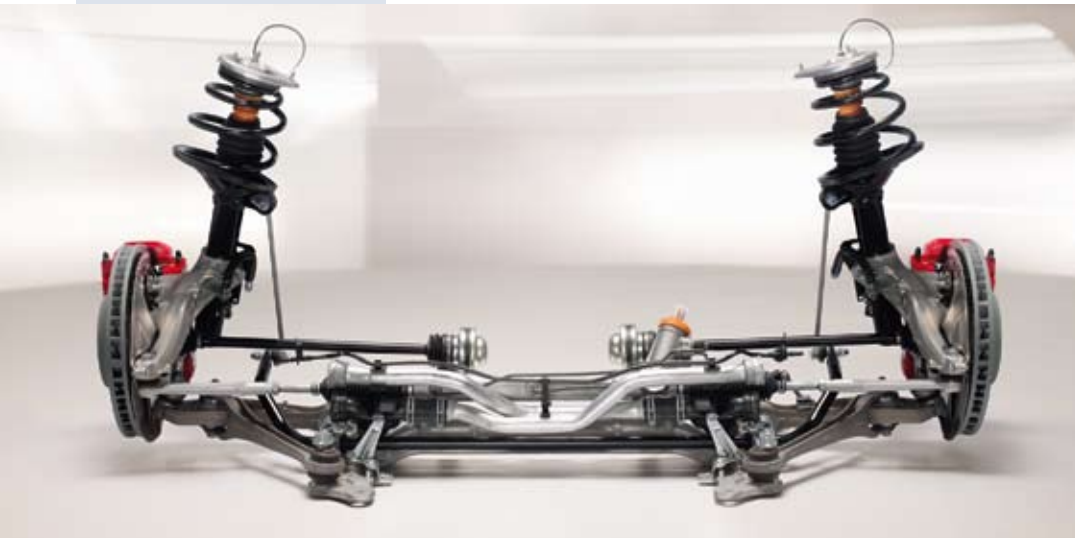

Front axle (911 Turbo)

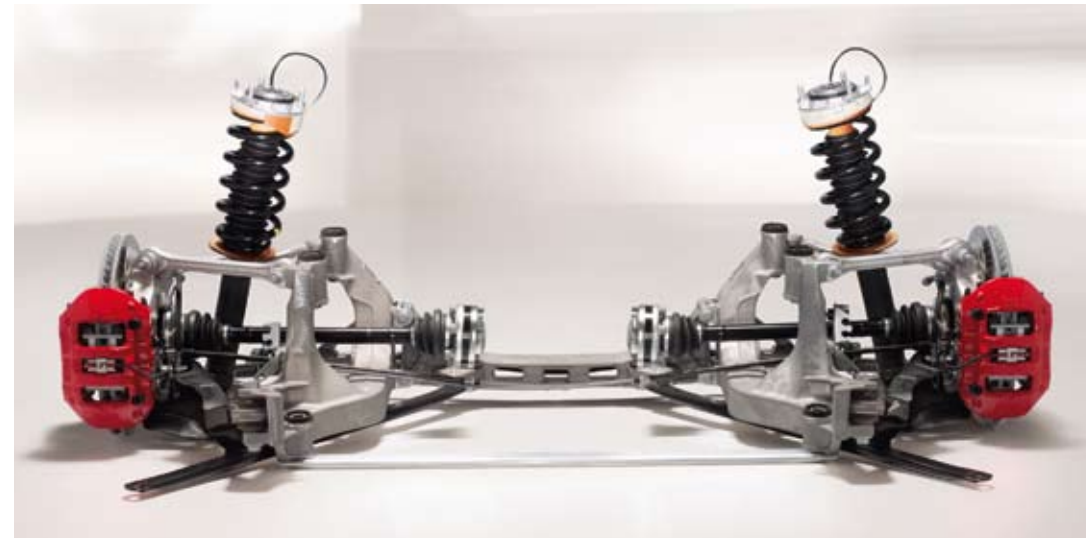

Rear axle (911 Turbo)

## Steering.

Sensitive and direct, the power-assisted steering also offers accurate feedback from the road. For a sports car, driver effort is minimal. In short: all the precision of a race-designed system, yet perfect for everyday road use.

One of the key features of the steering system is the variable-ratio gearing. Around the straight-ahead position, the ratio is less direct, enabling smoother manoeuvres on the motorway. It also reduces the risk of excessive steering inputs which could destabilise the car at high speed. Agility and feedback, however, are maintained.

Turn the wheel harder and the ratio becomes more direct, enabling better control through low-speed corners as well as easier parking manoeuvres. The turning circle is a modest 10.9 metres.

## 19-inch 911 Turbo II wheels.

Fitted as standard to 911 Turbo models, the 19-inch 911 Turbo II wheels seamlessly combine function and design.

The car has 8.5 J x 19 wheels at the front combined with 235/35 ZR 19 tyres. At the rear are 11 J x 19 wheels with 305/30 ZR 19 tyres. The wheels are forged, of course, to reduce weight and unsprung masses. The material is also very strong, making it possible to achieve a fine spoke wheel design which provides better ventilation of the brakes.

The five-spoke design is stylish and distinctive. The linear twin spokes have a high-sheen surface finish, contrasting with the titanium-coloured base paint. Part of the wheel rim also has a high-sheen finish.

The 19-inch 911 Turbo II wheels. Proof that dynamism can be expressed visually.

## 19-inch RS Spyder wheels with central locking device.

Reminiscent of the classic RS Spyder design, these forged aluminium wheels with a motorsport-derived central locking device are available on request for the 911 Turbo models and are fitted as standard to the new 911 Turbo S models. By reducing rotating masses, they deliver an even more agile driving experience. Benefiting from innovative ongoing developments to the engineering conventionally used only in a racing environment, the striking central locking devices offer effective protection against corrosion and are easy to clean.

Alternatively, the 19-inch 911 Turbo II wheels are available for the 911 Turbo S models at no extra cost.

## Tyre Pressure Monitoring (TPM).

Tyre Pressure Monitoring, included as standard equipment, warns against tyre pressure loss. The driver is informed via the on-board computer display.

The driver can check the pressures of all four tyres from the instrument cluster. Each time the tyres are re-inflated, or whenever a wheel has been changed, the updated tyre pressures are displayed quickly – for increased comfort and safety.



19-inch 911 Turbo II wheel



19-inch RS Spyder wheel with central locking device

**Porsche Stability Management (PSM).**

PSM, an automatic vehicle stability control system designed to aid the driver in critical road scenarios, is fitted as standard. Sensors monitor the direction, speed, yaw velocity (speed of rotation around the vertical axis) and lateral acceleration of the car. Using this information, it is possible to calculate the actual direction of travel at any given moment. If the car begins to oversteer or understeer, PSM applies

selective braking on individual wheels to restore stability and optimum speed. Whenever PSM is required to intervene, an indicator light in the cockpit flashes.

When accelerating on wet or other low-grip surfaces, PSM combines with PTM and uses the automatic brake differential (ABD) and anti-slip regulation (ASR) functions to maintain traction and stability. Included as standard equipment, PSM assists with high-precision inputs that enhance the agility of each model. When 'Sport' mode

is selected on the Sport Chrono Package Turbo with dynamic engine mount system (page 58), the PSM threshold is raised higher still to enable greater driver involvement – particularly at speeds of up to 70 km/h (44 mph).

PSM includes ABS to help minimise braking distances. System inputs are smooth and precise for greater driver comfort.

Active safety is further enhanced with the aid of two additional

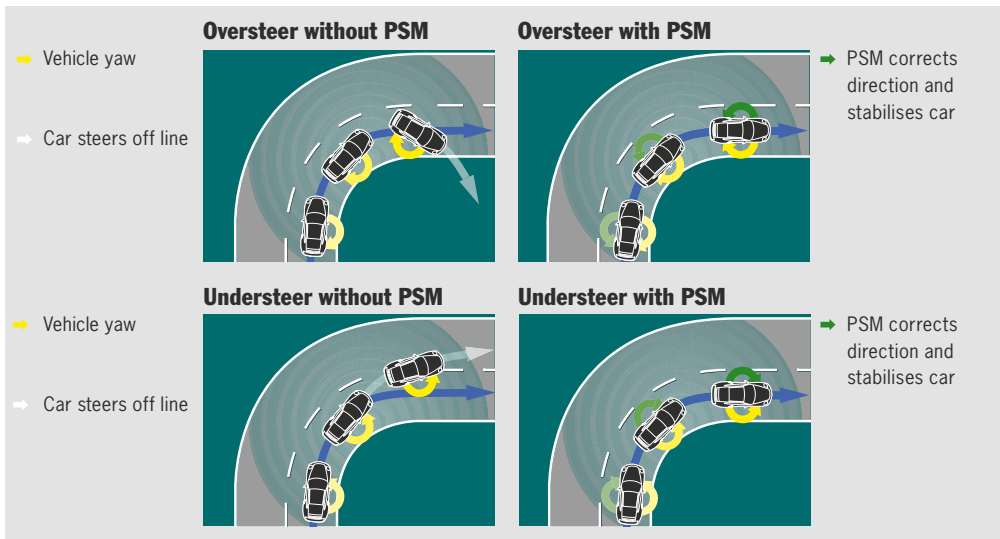

brake functions: electronic brake prefill and brake assist.

The prefill function is automatically enabled whenever the throttle pedal is suddenly released. The pressure in the brake lines is marginally increased, bringing each of the pads into light contact with the corresponding disc. If the driver then decides to use the brakes, the system can apply the maximum force with virtually no delay.

The brake assist function, by contrast, is specifically designed for use in emergency stops. When the speed of brake pedal application and the pressure on the brake pedal exceed a predefined threshold, the hydraulics automatically apply the necessary deceleration.

For a more actively involved driving experience, PSM can be manually disabled. PSM remains present in the background and will only intervene under heavy braking where at least one front wheel requires ABS assistance (in 'Sport' mode, if both front wheels require assistance). The automatic brake differential (ABD) remains active at all times.

### Sport Chrono Package Turbo with dynamic engine mount system.

The Sport Chrono Package Turbo with dynamic engine mount system is standard on 911 Turbo S models and available as an option for 911 Turbo models. This integrated system provides simultaneous enhancement for engine, chassis and transmission.

Key features include a digital and analogue stopwatch on the dashboard, a performance display, a personal memory function in the Porsche Communication Management (PCM), the SPORT button and – in combination with PDK – the SPORT PLUS button, and an additional display on the steering wheel which informs the driver if the SPORT buttons and

Launch Control have been activated. The 911 Turbo models additionally offer the 'overboost' function. This is how it works:

When 'Sport' mode is selected, the engine management system creates a much more aggressive response to pedal inputs. To do this, it implements an alternative throttle map which relates the pedal position in the footwell to a wider angle of opening in the throttle body. In higher gears, it uses a hard rev-limiter to protect the engine under power.

In the 911 Turbo models, under full acceleration, the maximum boost pressure in the lower and medium speed ranges is now temporarily increased by approximately 0.2 bar. As a result, engine torque is boosted by 50 Nm

to a maximum of 700 Nm for a limited period. (The 911 Turbo S models are configured to operate with a higher boost pressure level, which means that their maximum torque is always 700 Nm.)

In addition to the engine, 'Sport' mode is enabled in the standard Porsche Active Suspension Management (PASM) suspension. The dampers become firmer, enabling faster turn-in as well as better contact with the road.

In automatic mode of PDK, the basic gearshift pattern is switched to high-performance mode. The gear change action is virtually instantaneous, while the shift points are timed for maximum acceleration. Lift off the throttle – even at high revs – and the system automatically shifts down to apply engine braking. In manual shift mode, gear changing is faster and more dynamic.

Porsche Stability Management (PSM) is also adapted, with the intervention threshold raised. As a result, the car has a more natural response to lateral and longitudinal forces. Cornering agility is greatly enhanced, when both



braking to turn in and applying power on exit – particularly in low-speed bends. For even greater driving pleasure.

For maximum manoeuvrability, PSM can be partially disabled while the car is still in 'Sport' mode. PSM simply monitors the forces acting on the car and will only intervene in the most critical scenarios, e.g. when ABS assistance is required on both front wheels.

In conjunction with PDK (standard on 911 Turbo S models), the Sport Chrono Package Turbo with dynamic engine mount system has two additional functions that

can be activated via the SPORT PLUS button, for a sporty drive that borders on a motorsport experience.

The first function is 'Launch Control', which, for example when performing laps, helps you achieve optimum acceleration from a standing start, a racing start in other words.

The function works like this: press the SPORT PLUS button when the transmission is in 'D' or 'M'. Then, with your left foot, press the brake pedal and accelerate fully with the right foot. The car recognises 'Launch' mode from the accelerator kickdown

action and adjusts the engine speed to the optimum level, which is around 5,000 rpm. At the same time, boost pressure is increased to approximately 0.5 bar, engine torque is increased and the clutch is applied lightly. 'Launch Control' now appears in the steering wheel display. Now release the brake as quickly as you can – and feel the acceleration power unleashed to the road.



Steering wheel display with PDK and Sport Chrono Package Turbo

The second function is the 'motorsport-derived gearshift strategy'. Using this, Porsche Doppelkupplung (PDK) is geared up for the shortest possible shift times and optimum shift points for maximum acceleration – ideal for the racetrack.

A key component of the Sport Chrono Package Turbo with dynamic engine mount system is the stopwatch mounted on the dashboard. Porsche Communication Management (PCM, page 86) has a special performance display to view, store and evaluate lap times or other driving times. It shows the total driving time, lap distance, lap number and the lap times recorded so far. You can view the current fastest lap and the remaining range until empty. Travelled distances can be recorded and benchmark times defined.

The personal memory function of the Sport Chrono Package Turbo can also be used to store personalised settings for a range of systems, including the orientation lighting or air conditioning.

#### **Operation of the dynamic engine mount system.**

Stiffness and softness as required. That's the principle behind the dynamic engine mount system now being offered for the first time as part of the Sport Chrono Package Turbo. Essentially, it's an electronically controlled system for controlling the stiffness of the engine mounts.

The engine is bolted to the body using two mounts and follows Newton's law of inertia, namely that a body will continue to move in a uniform straight line unless

it is made to change its direction by a force acting upon it.

Put more simply: when you are driving into a bend, the vehicle will follow your steering but, at first, the mass of the engine won't. This means that the rear of the vehicle is pushed outwards because of the inert forces from the engine's mass acting on it.

The dynamic engine mount system minimises this effect. The steering angle longitudinal and lateral acceleration values are constantly recorded by sensors and the stiffness of the two engine mounts is changed automatically according to the driving style. This is achieved using a magnetisable (magneto-rheological) fluid and an electrically generated magnetic field. The magnetisable particles align with each other and the fluid's

viscosity changes. This alters the stiffness and absorption of the engine mounts: softer for greater comfort and less vibration when driving normally, harder for a more direct driving feel when driving more sportily.

The dynamic engine mount system also reduces the vertical oscillations of the engine when accelerating under full load. The result: greater and more uniform force on the rear axle, increased traction and better acceleration.

All this means two things: perceptibly more stable handling under load change conditions and in fast corners and a step closer to the ultimate sporty drive – combined with enhanced levels of comfort.





## Responsibility



One effective way of relaxing: breathe steadily.

Safety.

Quickening pulses whilst simultaneously creating calm. Yet another apparent contradiction typical of the performance of the 911 Turbo concept.

Headlights.

The Bi-Xenon headlight system is fitted as standard. The brightness of the lights is approximately twice as great as that of conventional halogen lights. Light output is improved and the road illuminated more uniformly on both

dipped and main beam, helping to minimise driver fatigue. Also included is dynamic range control to prevent hazardous dazzling of oncoming vehicles due to undulations in the road or the loading of the car. A headlight cleaning function is also incorporated.

Dynamic cornering lights (standard on 911 Turbo S models, optional for 911 Turbo models) offer particularly effective illumination of the road ahead, especially through bends. Sensors continuously monitor the speed, lateral acceleration and steering lock and, from these variables, calculate the course of the bend. This determines the angle of illumination for the dipped beam lights, up to a maximum of 15 degrees. On twisting roads, this means the course of the road and obstacles can be seen earlier by the driver.



Dynamic cornering lights

Lighting concept.

The lighting concept also benefits from the latest technology, in the form of high-performance LEDs for the horizontal front indicators and also for the separate daytime running lights, the taillights and the third brake light in the rear wing.

In addition to the distinctive look that makes the car very recognisable, the lighting also provides high illuminating power. The brake lights also respond very quickly, meaning that following traffic is alerted sooner. Plus the lighting saves energy, is environmentally sound and has a longer service life in comparison to conventional bulbs.

When the vehicle is opened or closed using the key remote, the 'Welcome Home' lighting function automatically switches on the LED daytime running lights.

Two additional lights inside each door ensure you see and are seen better when getting into and out of the car.

**Brakes.**

On a 911 Turbo, there is one thing above all else that both the accelerator and brake pedals deliver when you press them – and that’s excitement.

The standard braking system of the 911 Turbo models features six-piston fixed calipers at the front and four-piston fixed calipers at the rear.

The red-painted calipers have a monobloc (one-piece) aluminium construction offering greater stability, better ‘bite’ characteristics under heavy braking and a further reduction in unsprung weight. The brakes are quick to apply and release, whilst the pedal travel is short and the bite point precise and consistent.

The front and rear discs have a generous diameter of 350 mm. All four discs are cross-drilled for better performance in the wet. The distinctive drill-hole pattern enables a faster response by allowing rapid dispersal of the water vapour generated under braking.

The discs are also internally vented for better heat dispersal. The result: excellent stability in all conditions. Cooling air is directed onto the brakes to further improve performance. A powerful 9-inch tandem brake booster unit enables easier pedal inputs.



Standard front brake (911 Turbo)



Braking distances are further reduced with the aid of two functions in the standard Porsche Stability Management (PSM): electronic brake prefill and brake assist (page 57).

The new 911 Turbo S models come equipped with the Porsche Ceramic Composite Brake (PCCB, see following pages) as standard.



PCCB

**Porsche Ceramic Composite Brake (PCCB).**

The new 911 Turbo S models are equipped as standard with a braking system that has already proved it can withstand even the toughest racing conditions, such as those encountered in the Porsche Mobil 1 Supercup. That system is the Porsche Ceramic Composite Brake (PCCB). PCCB is available as an option for 911 Turbo models.

The ceramic discs have a diameter of 380 mm at the front and 350 mm at the rear. The discs are made from a specially treated carbon-fibre compound that is silicated in a high-vacuum process at 1,700 °C. The resulting material is not only much harder than metal, it is also more resistant to heat.

Even at high temperatures, the thermal resistance of the PCCB disc ensures excellent dimensional stability. The ceramic material is totally resistant to corrosion and offers excellent acoustic damping properties.

The pads are mounted in six-piston monobloc aluminium fixed calipers at the front, with four-piston units at the rear. The resulting brake forces are both extremely high and remarkably consistent. The pedal response is fast and precise with only moderate input required.



PCCB enables shorter braking distances in even the toughest road and race conditions. Excellent fade resistance ensures greater balance when slowing from racetrack speeds.

The key advantage of PCCB is the total weight saving of

approximately 50% over metal discs with similar construction and dimensions. As well as enhancing performance and fuel economy, this represents a major reduction in both the unsprung and rotating masses. This, of course, produces additional benefits in terms of comfort

and road-holding on uneven road surfaces as well as general handling and agility.

Please note that circuit racing, trackday use and other forms of performance driving can significantly reduce the service life of even the most durable pads and

discs. As with conventional high-performance braking systems, we recommend that all brake components be professionally inspected and replaced where necessary after every track event.



- Sheet steel
- Tailored blanks
- Super high-strength steel
- Ultra high-strength steel
- Aluminium

**Driver and passenger airbags.**

The two full-size airbags can be inflated in two stages, depending on the severity of the impact.

In a low-speed crash, the airbags are only partially inflated, thereby minimising discomfort to the occupants.

**Bodyshell structure.**

The reinforced bodyshell contains a highly resilient passenger cell offering exceptional crash protection. At the front of the car, the cell is protected by a patented system of longitudinal and transverse members (1). In the event of an accident, it disperses the force of the impact and minimises deformation of the passenger cell. Additional features include an ultra-rigid bulkhead cross-member (2) made from super high-strength

steel. This element is designed to absorb impact forces from the longitudinal members and thus protect the front footwells. The reinforced doors (3) also contribute to the overall rigidity of the car. An additional load path (4) is used to channel energy through the upper part of the shell and thus further protect the passenger cell.

In minor collisions, easily replaceable impact absorbers (5) protect the bodyshell.



**Porsche Side Impact Protection System (POSIP).**

POSIP, fitted as standard, consists of side impact protection beams in the doors and two side airbags on each side, namely a thorax airbag located in the side of each backrest and a head airbag incorporated within each door. Each airbag has an approximate volume of 8 litres, ensuring excellent

protection in the event of side impact.

Additional safety features include the headrests which form an integral part of each seat, an energy-absorbing steering column, three-point seat belts with height adjustment (Coupés only), seat belt pre-tensioners and force limiters and energy-absorbing elements in the dashboard.

**Safety in the 911 Turbo Cabriolets.**

One fundamental principle at Porsche is to provide high levels of occupant protection, regardless of whether the vehicle is a closed or open-top design.

Torsional rigidity and flexural strength are exemplary for a two-plus-two convertible. Body flexing



is minimal even on the most poorly surfaced roads, ensuring better handling and greater active safety.

Occupants are protected by an automatically deploying roll-over system if the vehicle were to

overturn. Two spring-loaded roll-over bars are neatly incorporated behind each of the rear seats. The roll-over sensor – part of the airbag control unit – continuously monitors the car's pitch and roll, contact with the road, as well as lateral and longitudinal forces.

If the car were to overturn, the top-padded bars would be deployed instantly.

Of course, the 911 Turbo Cabriolets also come as standard with the Porsche Side Impact Protection System (POSIP).

**What's urgently expected of today's management teams? Responsibility.**

**Environment.**

**Think twice about every additional ounce. Get more power out of every drop of fuel. Examine every path to a solution. Why? Well, because it's our duty. And because our efforts to achieve greater efficiency will also give us the engineering lead.**

In an era of intensifying debate about CO<sub>2</sub> emissions, every automotive manufacturer is being asked the question, 'What is your answer to the issue of fuel consumption?' Our answer has long been the same: maximum efficiency.

Porsche has been reducing the CO<sub>2</sub> emissions of its vehicles by an average of around 1.7%\* every year for the past 15 years. In relation to engine power, Porsche is already among those manufacturers achieving the lowest CO<sub>2</sub> emissions. This has been achieved

through efficient drive concepts (e.g. DFI), lightweight construction, optimised aerodynamics and low rolling resistance.

This high level of environmental responsibility is demonstrated by our approach to environmental management at the Porsche development centre in Weissach. Here, all technological developments are carried out with environmental protection in mind. The objective

is to achieve pure performance, but not at the expense of the environment.

You will find more information in our separate brochure 'Porsche and the Environment' or at [www.porsche.com](http://www.porsche.com).

**Exhaust emission control.**

The 911 Turbo and the 911 Turbo S models comply with stringent emissions standards, including Euro 5 in Europe and LEV II/LEV in the USA. Porsche vehicles demonstrate that even high-performance sportscars can achieve moderate emission values in their respective category. This makes them not just extremely exciting sportscars, but very clean ones too.



\* The stated reduction in fuel consumption has been calculated from the NEDC (New European Drive Cycle) fuel consumption figures for the respective model years of the vehicles and in relation to the applicable European legislation.

**Fuel consumption and recycling.**

Intelligent lightweight construction is a fundamental aspect of design at Porsche. For both economic and ecological reasons. This forms the basis for achieving low fuel consumption values combined with outstanding performance.

It is economical thanks to the high proportion of cast aluminium alloys, magnesium, plastics and high-strength sheet steel, the latter being much stronger and lighter than conventional steel. The 911 Turbo and 911 Turbo S models consist of almost 20% lightweight alloys.

It is also ecological because all materials used are carefully selected. Only the latest, environmentally sound components are used. All lightweight materials are easily recyclable, while the variety of synthetic components has been reduced. Recycled plastics are used in all areas of the car where they meet our exacting technical requirements. To simplify process-

ing, all materials are labelled for separate recycling.

In short, approximately 95% of today's 911 Turbo and 911 Turbo S models can be recycled.

Porsche primarily uses environmentally friendly water-based paints. All areas of the 911 Turbo and 911 Turbo S models are free from asbestos, CFCs and components manufactured using CFCs. Because at Porsche, helping the environment doesn't start at the end of a vehicle's life. It starts right at the beginning at the planning and development stages.

**Fuel.**

The current 911 Turbo generation is already compatible with fuels that have an ethanol content of up to 10%. A 'biofuel' made from naturally replenishing materials, ethanol has a positive impact on the carbon dioxide balance since the plants grown for its production also absorb carbon dioxide from the atmosphere.



Hydrocarbon emissions from the fuel supply system are low, achieved through a combination of an active carbon filter and a

special fuel-tank coating. All fuel lines are made from aluminium, whilst those carrying vapours are made from multi-layer plastic.

**Noise.**

The 911 Turbo and 911 Turbo S models comply with all current noise regulations – without resorting to engine encapsulation. To achieve this, we've eliminated noise at source: engine compo-

ponents are more rigid, moving parts lighter and tolerances reduced to a minimum. High-efficiency silencers and resonators in the intake system help to reduce noise even further. For the entire service life of the car.



## Personality



**Why do you need huge gestures when the signs are clear?**

**Comfort.**

- An expressive design.**
- Well conceived technology.**
- A consistently sporty style.**
- No gimmicks. Why should the rules for performance be any different for the interior?**

**Interior.**

Efficient ergonomics is the guiding theme for the interior. The steering wheel offers 40 mm of adjustment for both height and reach. A multifunction steering wheel – with or without steering wheel heating – is available on request. The distinctively

designed gear lever (for the six-speed manual gearbox) and PDK gear selector are easy to operate.

Porsche Communication Management (PCM) with a touchscreen is fitted as standard, as is the integral GPS navigation module with hard drive navigation (page 86). The new 911 Turbo S models

come equipped with an integrated six-disc CD/DVD autochanger and cruise control as standard. The air-conditioning system with an active carbon filter is fully automatic.

The leather finish on the seats, dashboard, doors and rear side panels is pleasing to the touch. Available exclusively for 911 Turbo S models as standard is the choice of two-tone leather interior in either Black and Cream or Black and Titanium Blue.

The centre console and door storage compartments provide storage space for personal items. Below the passenger airbag are two cup holders and below these is the glove compartment with CD storage.

Two 12-volt sockets (including the cigarette lighter) provide power for a range of electrical devices.



Instruments in the 911 Turbo with PDK

**Instruments.**

The classic Porsche grouping of five round instruments offers a clear overview of all key information.

The digital display in the centre-left dial (speedometer) provides main and trip odometer readings. The central rev counter, featuring the 'turbo' or turbo S' logo, includes the standard on-board computer display. This multi-purpose field contains a permanent digital speedometer as well as the upshift display on manual models. The following optional

information can also be displayed: boost pressure, average speed, average fuel consumption, tyre pressure, current radio station, navigation instructions and remaining range till empty. When 'Sport' mode is selected on the Sport Chrono Package Turbo in a 911 Turbo model equipped with dynamic engine mount system, the temporary increase in maximum torque is clearly indicated by an arrow symbol in the boost pressure display. The third display, in the centre-right dial, shows the time and outside temperature.



Interior of the 911 Turbo in natural leather Carrera Red

**Comfort seats.**

The comfort seats fitted as standard in the 911 Turbo and 911 Turbo Cabriolet models feature full electric adjustment of fore/aft position, height, backrest angle, squab angle and lumbar support (also available at no extra cost for 911 Turbo S models).

The high side bolsters provide excellent lateral support, without restricting occupant comfort. The generous range of adjustment options on the standard seats means that virtually every driver can find the ideal position, regard-

less of physical build. A memory function stores personal preferences for seat position, lumbar support and exterior mirrors.

**Sports seats.**

Available as a no-cost option, these mechanical sports seats offer firmer upholstery as well as higher side bolsters on the backrest and squab for added lateral support. The fore/aft position and height are manually adjustable, while the backrest is electrically controlled.

**Adaptive sports seats.**

Adaptive sports seats are fitted as standard in the new 911 Turbo S models (optional for 911 Turbo models). They offer individual electric adjustment of fore/aft position, height, backrest angle, lumbar support, squab side bolsters and backrest side bolsters for maximum comfort on long-distance journeys or lateral support on the racetrack.

The additional memory function covers both exterior mirrors and all seating positions on the driver's side, except side bolster settings.

**Sports bucket seats.\***

For the ultimate sports experience, choose the new sports bucket seats featuring a folding backrest, integral thorax airbag and manual fore/aft adjustment (available as a no-cost option for 911 Turbo S models). The backrest shell is made from glass/carbon-fibre reinforced plastic and has a stylish carbon-weave finish.

Unusually, the pivot points of the seat backrest are positioned high in the side bolsters, guaranteeing lateral support – characteristic of racing bucket seats – in the pelvis area too. Unlike conventional bucket seats, the folding backrest enables easy access to the rear luggage area.

**Seat ventilation.**

As an option, seat ventilation is available for the comfort seats when fitted in combination with seat heating. Active ventilation of



Rear compartment space

the perforated seat centre pad and backrest, along with passive ventilation on the side bolsters, generates a flow of air.

**Rear seats.**

The rear seats are surprisingly comfortable for a sports car. The seat backrests fold down, giving you a generous rear luggage area of 190 litres (155 litres in the 911 Turbo Cabriolet models).

**Child seats.\***

Child seats with and without ISOFIX mountings can be fitted in any vehicle of the 911 Turbo model range. The Porsche Tequipment accessory range includes the necessary fittings and a deactivation function for the passenger airbag. The complete range of child seats is available from Porsche Tequipment. Please ask your Porsche Centre for details.

\* Child seats must not be used with the sports bucket seats.



Comfort seat with seat ventilation



Adaptive sports seat



Sports bucket seat



Luggage compartment with two PTS 'Ultralight edition' trolley cases, size M

**HomeLink®.**

The optional freely programmable garage door opener is incorporated into the roof console and offers remote control of up to three garage door, gate, home lighting and/or alarm systems.

**Luggage compartment.**

In addition to the rear luggage area, the luggage compartment at the front has a capacity of 105 litres. The entire luggage

compartment is lined with high-quality scratch-resistant materials.

**Roof transport system.**

The optional roof carrier system for the 911 Turbo (Coupé versions only) is aerodynamically efficient, extremely lightweight and easy to fit. The system can be combined with a range of attachments, such as a roof box and carriers for bikes, skis and snowboards. Maximum roof load is 75 kg.

**Anti-theft protection.**

An engine immobiliser with in-key transponder as well as a powerful alarm system featuring contact-sensitive exterior protection and radar-based interior surveillance are standard on all models.

**Vehicle Tracking System.**

An optional factory-fitted preparation enabling future installation of a vehicle tracking system is obtainable from Porsche Tequipment. This system allows a stolen vehicle to be traced throughout most of Europe. The package includes a special wiring loom and a high capacity battery. A tilt sensor for the alarm system is also part of the preliminary fittings.

**Automatically dimming mirrors.**

An auto-dimming function is included as standard for the interior and exterior mirrors. Also included is an integrated rain sensor for the front wiper system.



Roof transport system

**ParkAssist.**

This standard feature is automatically enabled whenever you select reverse gear. Move too close to a stationary object and a warning signal is emitted. Continue to reverse and the tone increases in frequency.

The ultrasonic sensors are neatly concealed in the rear bumper.

**Cruise control.**

Standard on 911 Turbo S models (optional for 911 Turbo models), cruise control has an effective

speed range of 30–240 km/h (19–149 mph). The system is operated using a separate control stalk on the steering column and can even be used in first gear.



Porsche Communication Management (PCM)



Cordless handset

**Porsche Communication Management (PCM).**

Fitted as standard, PCM is the central information and communications system. It is both multifunctional and very easy to operate.

The main feature is the 6.5-inch touchscreen for intuitive control.

For radio listeners, there is an FM twin tuner with RDS, which constantly scans for the best

signal for the selected station, and up to four radio aerials for optimum reception.

The integrated single CD/DVD drive of the 911 Turbo models can, in combination with the standard BOSE® Surround Sound System, replay music from audio and video DVDs in 5.1 Discrete Surround Format. As an option, a six-disc CD/DVD autochanger can also be integrated in PCM (standard on 911 Turbo S models).

The standard GPS navigation module has a hard drive with map data for most European countries. When viewing a map, it is possible to select either a 3D perspective or a 2D display.

**Electronic logbook.**

The optional electronic logbook enables automatic recording of mileage, route distance, date and time, starting point and destination for each journey.

**TV tuner.**

A TV tuner, available as an option, receives unencoded analogue and digital television broadcasts (DVB-T) to provide entertainment between journeys. For your safety, the TV picture cannot be displayed while the vehicle is in motion.

**Voice control system.**

Almost all of the functions of PCM can be controlled via the optional voice control system. The main menu item is read aloud exactly as it is displayed on the screen and the voice control system recognises commands or number sequences, irrespective of the speaker. It gives audible feedback and guides you through the functions. There is no need to 'train' the system. Phone book entries can be retrieved, a radio station selected or the navigation destination entered directly by speaking whole words.

**Telephone module for PCM.\***

The standard GSM telephone module offers convenience and excellent reception. By inserting a SIM card directly into PCM's integral SIM card reader, calls can be made using the hands-free facility. For even more convenience, the Bluetooth® capability of a mobile phone can be used to make calls via the SIM Access Profile (SAP). Once automatic pairing is complete, the mobile phone's aerial is switched off to conserve battery charge and the phone operates via the car aerial. Depending on the mobile phone model, this gives access not only to the numbers on the SIM card, but also to the phone's internal memory. Depending on the phone, it can also be controlled using PCM, the optional multifunction steering wheel or the optional voice control system, without it ever leaving your pocket.

In addition, the telephone module enables you to establish a Bluetooth® link with those mobile phones that only support the Handsfree Profile (HFP). In this case, the GSM connection is always established through the

aerial of the mobile phone. PCM acts as a hands-free system and you can leave the mobile phone tucked away. On request, a cordless handset for the telephone module is also available. However, the handset cannot be used for Bluetooth® links established using the Handsfree Profile (HFP).

\* Note: see page 104.



**Universal audio interface.**

With this standard feature, the storage compartment in the centre console will contain three connections: one for your iPod®, one for a USB stick/MP3-player and one as an AUX interface for any chosen compatible audio source. The iPod® or USB stick can be operated conveniently and safely via PCM, the optional multi-function steering wheel or the optional voice control system.

**BOSE® Surround Sound System.**

The standard BOSE® Surround Sound System is optimally matched to the specific interior acoustics. A total of 13 loudspeakers (12 in the 911 Turbo Cabriolet models), including an

active subwoofer and central speaker, and a seven-channel digital amplifier with a rated output of 385 watts ensure an impressive sound experience.

When playing music from audio or video DVDs, the system now has the impressive sound spectrum of digital 5.1 recording.

Five dedicated audio channels (front left, front right, centre, surround left, surround right) and a power channel for the bass frequencies deliver a sound that is as authentic as it is natural. The 5.1 Discrete Surround Sound is balanced, lifelike and crystal clear. A 360-degree sound experience that is as close to a live performance as you could imagine.

1. System electronics
2. 7.0-cm mid-range centerfill speaker
3. 2.5-cm Neodym high-range speakers
4. AudioPilot® microphone
5. 8.0-cm Neodym mid-range speaker
6. 20.0-cm Nd® low-range speaker
7. 2.5-cm Neodym high-range speaker
8. 8.0-cm Neodym mid-range speaker
9. 911 Turbo Coupé models: two 13.0-cm low-range speakers in 14-litre bass reflex enclosure with TSM switching amplifier. 911 Turbo Cabriolet models: one low-range speaker in bass reflex enclosure with TSM switching amplifier in front passenger footwell

Naturally, you can also play conventional CDs, either in stereo or in one of the surround modes generated by the BOSE® Centerpoint® technology. The algorithm of Centerpoint® II extracts a precise and realistic sound from the stereo signal.



To complement these features, the BOSE® Surround Sound System offers a comprehensive selection of equaliser presets for customised sound. The dynamic loudness function emphasises the bass notes as the volume decreases to compensate for the diminishing sensitivity of the

human hearing at these frequencies. In addition, the AudioPilot® Noise Compensation Technology uses a microphone to continuously measure the ambient noise inside the vehicle and adapts music playback automatically, to give a constant sound quality in all driving conditions.

In short, you are sitting in a concert hall – one of the fastest there is.

Why it's worth letting your imagination run free.

Personalisation.

The success story of the 911 Turbo is always a very personal one. Because power also means providing plenty of scope for individual interpretation.

Colours.

Choice of colour is always an expression of personal character.

So it's good that our wide variety of colour options does this principle justice.

In total, you can choose from four solid and eight metallic colours, four 'special' paint finishes and four hood colours. Plus for the interior, there's a choice of nine colours, three two-tone combinations and, exclusively for 911 Turbo S models, two additional

two-tone combinations for the leather interior.

If you can't find the colour you'd like, we can probably mix it for you. For more information, see the Porsche Exclusive 911 catalogue.

To see how your individual choices would look on your car, visit [www.porsche.com](http://www.porsche.com) and use the online Porsche Car Configurator.



**Solid exterior colours.<sup>1</sup>**

**Metallic exterior colours.<sup>1</sup>**

**Special exterior colours.**

**Hood colours.**



Black

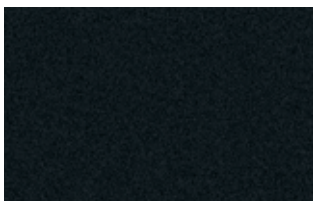

Basalt Black Metallic



Macadamia Metallic

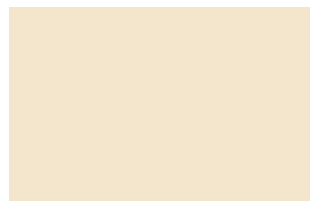

Cream White



Black



Guards Red

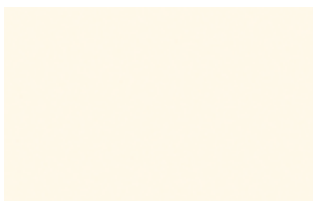

Platinum Silver Metallic<sup>2</sup>

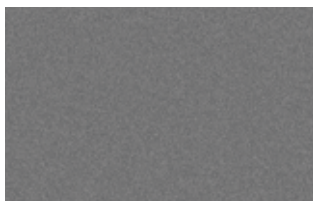

Meteor Grey Metallic

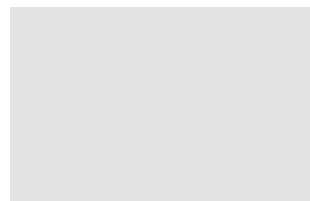

GT Silver Metallic



Stone Grey

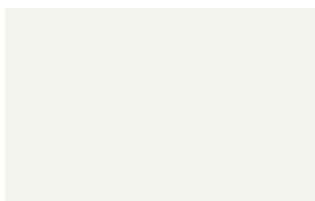

Carrara White



Dark Blue Metallic



Aqua Blue Metallic



Amethyst Metallic<sup>2</sup>



Metropole Blue



Speed Yellow



Ice Blue Metallic<sup>3</sup>



Porsche Racing Green Metallic



Ruby Red Metallic



Cocoa

<sup>1</sup> Solid and metallic colours are all no-cost options.

<sup>2</sup> Available from 09/2010 at the earliest.

<sup>3</sup> For 911 Turbo models, available from 09/2010 at the earliest.

Note for 911 Turbo and 911 Turbo S models: up to 07/2010 available as metallic paint: Arctic Silver Metallic  
up to 07/2010 available as special colour: Atlas Grey Metallic

**Standard interior colours.**

**Leather/soft-touch paint<sup>1</sup>  
Interior colour.**



Black

**Carpet.**



Black

**Rooflining.<sup>2</sup>**



Black



Stone Grey



Stone Grey



Stone Grey

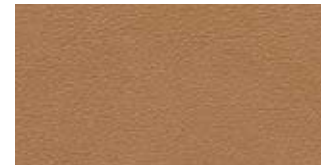

Sand Beige



Sand Beige



Sand Beige



Ocean Blue



Ocean Blue



Ocean Blue

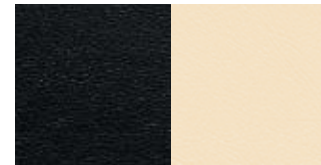

Black and Cream<sup>3</sup>

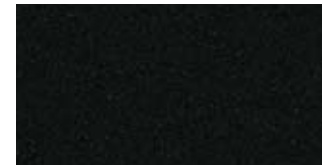

Black



Black

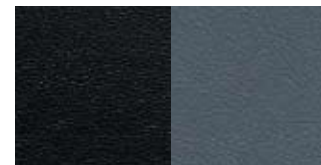

Black and Titanium Blue<sup>3</sup>



Black



Black

**Special/two-tone interior colours<sup>4</sup>.**

**Leather/soft-touch paint  
Interior colour.**



Terracotta<sup>5</sup>

**Carpet.**



Terracotta

**Rooflining.<sup>2</sup>**



Black



Cocoa<sup>5</sup>



Cocoa



Black



Black and Terracotta<sup>4,6</sup>



Terracotta



Black



Black and Stone Grey<sup>4,7</sup>



Stone Grey



Black

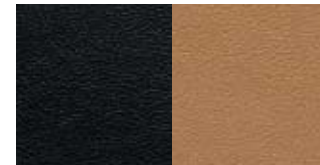

Black and Sand Beige<sup>4,7</sup>



Sand Beige



Black

**Natural leather interior.**

**Leather/soft-touch paint  
Interior colour.**



Dark Grey Natural<sup>8</sup>

**Carpet.**



Dark Grey Natural

**Rooflining.<sup>2</sup>**



Black



Natural Brown<sup>5</sup>



Natural Brown



Black



Carrera Red<sup>5</sup>



Carrera Red



Black

See price list for recommended colour combinations.

- <sup>1</sup> Soft-touch paint in interior colour; sun visors and inner door sill guards with film finish in interior colour.
- <sup>2</sup> Rooflining in Alcantara (Coupé) or black fabric (Cabriolet).
- <sup>3</sup> Available for 911 Turbo S models only. Interior in black leather with the following surfaces in the chosen combination colour of Cream or Titanium Blue: door panels, seat centres front and rear. Decorative stitching in selected interior colour: dashboard upper section, door panels upper section, seats front and rear.
- <sup>4</sup> Two-tone interior: black leather finish on dashboard upper section including instrument shroud, dashboard forward section including front passenger airbag cover, steering wheel rim and airbag module, door upper panels, rear side panel upper sections, A-pillar/windscreen top trim, B/C-pillar trim (Coupé). All other surfaces in chosen combination colour.
- <sup>5</sup> Soft-touch paint in interior colour; sun visors and inner door sill guards with black film finish.
- <sup>6</sup> Soft-touch paint in interior colour or black; sun visors and inner door sill guards with black film finish.
- <sup>7</sup> Soft-touch paint in interior colour or black; sun visors with black film finish, and inner door sill guards with film finish in interior colour.
- <sup>8</sup> Soft-touch paint in black; sun visors and inner door sill guards with black film finish.



**Personalisation options and factory collection.**

Is there anything better than the 911 Turbo concept? Of course there is. Your interpretation of that concept. What better way to complement this captivating sports car than by using the power of your imagination?

To enhance the individuality of your car – both inside and out – you can choose from a range of individual items of equipment and

equipment packages. Detailed information can be found on the following pages and in the separate price list.

To make your 911 Turbo or 911 Turbo S model even more of an individual statement, please ask about the Porsche Exclusive factory-fitted modifications.

You can also continue to enhance your car with Porsche Tequipment. Numerous examples can be found in the respective

brochures. For more information, please consult your Porsche Centre.

Then comes the moment when you take delivery of your dream car. Where better to do it than at the place where the success story began, in Zuffenhausen? For full details about the factory collection option, please consult the price list.



911 Turbo Cabriolet with interior in two-tone combination (Black and Stone Grey)

Option	911 Turbo	911 Turbo Cabriolet	911 Turbo S	911 Turbo S Cabriolet	I no.	Page
<b>Exterior.</b>						
• Special colours	<input type="radio"/>	<input type="radio"/>	<input type="radio"/>	<input type="radio"/>	Code	93
• Individual colours	<input type="radio"/>	<input type="radio"/>	<input type="radio"/>	<input type="radio"/>	Code	
• Dynamic cornering lights	<input type="radio"/>	<input type="radio"/>	<input checked="" type="radio"/>	<input checked="" type="radio"/>	603	65
• Deletion of model designation	W	W	W	W	498	
• ParkAssist (parking aid at rear)	<input checked="" type="radio"/>	<input checked="" type="radio"/>	<input checked="" type="radio"/>	<input checked="" type="radio"/>	635	85
• Aerokit Turbo	<input type="radio"/>	–	<input type="radio"/>	–	XAF	99
• Rear wiper	<input type="radio"/>	–	<input type="radio"/>	–	425	
• Windscreen with grey top tint	<input checked="" type="radio"/>	<input checked="" type="radio"/>	<input checked="" type="radio"/>	<input checked="" type="radio"/>	567	
• Electric slide/tilt sunroof	<input type="radio"/>	–	<input type="radio"/>	–	650	
• Hardtop	–	<input type="radio"/>	–	<input type="radio"/>	550	25, 99
• Roof transport system	<input type="radio"/>	–	<input type="radio"/>	–	549	84
<b>Engine, transmission and chassis.</b>						
• Porsche Doppelkupplung (PDK)	<input type="radio"/>	<input type="radio"/>	<input checked="" type="radio"/>	<input checked="" type="radio"/>	250	42
• Porsche Ceramic Composite Brake (PCCB)	<input type="radio"/>	<input type="radio"/>	<input checked="" type="radio"/>	<input checked="" type="radio"/>	450	68
• Porsche Torque Vectoring (PTV)	<input type="radio"/>	<input type="radio"/>	<input checked="" type="radio"/>	<input checked="" type="radio"/>	220	50
• Sport Chrono Package Turbo with dynamic engine mount system	<input type="radio"/>	<input type="radio"/>	<input checked="" type="radio"/>	<input checked="" type="radio"/>	640	58
• Wheel centres with full-colour Porsche Crest	<input type="radio"/>	<input type="radio"/>	W	W	446	
• 19-inch RS Spyder wheels with central locking device	<input type="radio"/>	<input type="radio"/>	<input checked="" type="radio"/>	<input checked="" type="radio"/>	422	54
• 19-inch 911 Turbo II wheels	<input checked="" type="radio"/>	<input checked="" type="radio"/>	W	W	421	54

The vehicles pictured in the chapter on personalisation may include additional options not featured in this catalogue. For information on these options, please consult your Porsche Centre. For information on the options featured in this catalogue, please refer to the price list.



911 Turbo with Aerokit Turbo and 19-inch RS Spyder wheels



911 Turbo Cabriolet with hardtop

– not available     I number/extra-cost option     standard equipment    W no-cost option

Option	911 Turbo	911 Turbo Cabriolet	911 Turbo S	911 Turbo S Cabriolet	I no.	Page
<b>Interior.</b>						
• HomeLink® (programmable garage door opener)	○	○	○	○	608	84
• Cruise control (automatic speed control)	○	○	●	●	454	85
• Comfort seats with driver memory	●	●	W	W	P15	82
• Sports seats	W	W	W	W	P77	82
• Adaptive sports seats with driver memory	○	○	●	●	P01	82
• Sports bucket seats	○	○	W	W	P03	83
• Heated seats	○	○	○	○	342	
• Seat ventilation	○	○	○	○	541	83
• Steering wheel heating	○	○	○	○	345	
• Fire extinguisher	○	○	○	○	509	
• Floor mats	○	○	○	○	810	

**Interior: leather and natural leather.**

• Leather interior package						
– in standard colour	●	●	●	●	Code	
– in two-tone leather	–	–	●	●	Code	21, 23
– in special colour	○	○	○	○	Code	
– in two-tone combination	○	○	○	○	970	102
– in natural leather	○	○	○	○	998	16, 80
– in individual colour	○	○	○	○	Code	
• Three-spoke multifunction steering wheel	W	W	W	W	844	102
• Three-spoke sports steering wheel with gearshift paddles	○	○	●	●	840	44
• Soft ruffled leather on seats	○	○	○	○	982	

The vehicles pictured in the chapter on personalisation may include additional options not featured in this catalogue. For information on these options, please consult your Porsche Centre. For information on the options featured in this catalogue, please refer to the price list.

Option	911 Turbo	911 Turbo Cabriolet	911 Turbo S	911 Turbo S Cabriolet	I no.	Page
<b>Interior: macassar (dark wood with satin finish).</b>						
• Macassar interior package	○	○	○	○	801	102
• Three-spoke multifunction steering wheel in macassar	○	○	○	○	847	102
<b>Interior: carbon.</b>						
• Carbon interior package	○	○	○	○	803	103
• Three-spoke multifunction steering wheel in carbon	○	○	○	○	845	103
• Door sill guards in carbon	○	○	○	○	X69	
<b>Interior: Aluminium Look/aluminium/stainless steel.</b>						
• Three-spoke multifunction steering wheel in Aluminium Look	○	○	○	○	XPU	103
• Gear and handbrake levers in aluminium I	○	○	–	–	ECA	103
• PDK gear selector and handbrake lever in aluminium	○	○	○	○	ECB	

– not available    ○ I number/extra-cost option    ● standard equipment    W no-cost option



Interior in two-tone combination (Black and Stone Grey), three-spoke multifunction steering wheel



Carbon interior package, three-spoke multifunction steering wheel in carbon



Macassar interior package, three-spoke multifunction steering wheel in macassar



Three-spoke multifunction steering wheel in Aluminium Look, gear and handbrake levers in aluminium

The vehicles pictured in the chapter on personalisation may include additional options not featured in this catalogue. For information on these options, please consult your Porsche Centre. For information on the options featured in this catalogue, please refer to the price list.

Option	911 Turbo	911 Turbo Cabriolet	911 Turbo S	911 Turbo S Cabriolet	I no.	Page
<b>Audio and communication.</b>						
• Electronic logbook	○	○	○	○	641	86
• Voice control system	○	○	○	○	671	87
• Telephone module <sup>1,2</sup>	●	●	●	●	666	87
• Cordless handset for telephone module	○	○	○	○	669	86
• Six-disc CD/DVD autochanger <sup>4</sup>	○	○	●	●	693	86
• Universal audio interface (AUX, USB, iPod®) <sup>5</sup>	●	●	●	●	870	88
• TV tuner	○	○	○	○	676	87
• External aerial	W	W	W	W	461	



Universal audio interface

<sup>1</sup> For information on compatible mobile phones, please visit [www.porsche.com](http://www.porsche.com) or contact your Porsche Centre.

<sup>2</sup> Telephone module in HFP mode: The use of a mobile phone inside a car may cause an increase in the interior electromagnetic field strength and, accordingly, in the electromagnetic radiation to which passengers are exposed. The use of the telephone module for PCM via Bluetooth® SAP connection or with inserted SIM card prevents exposure to electromagnetic radiation as only the car's external aerial is ever used.

<sup>3</sup> Mobile phone preparation: The use of a mobile phone inside a car may cause an increase in the interior electromagnetic field strength and, accordingly, in the electromagnetic radiation to which passengers are exposed. If a cradle is used to mount the mobile phone, the field strength in the passenger compartment can be reduced because the phone can be connected up to the external aerial (feature depends on how specific mobile phones connect to the cradle). For information about the availability of a cradle for your mobile phone, please contact your Porsche Centre. The use of the telephone module for PCM via Bluetooth® SAP connection or with inserted SIM card prevents exposure to electromagnetic radiation as only the car's external aerial is ever used.

<sup>4</sup> May be incompatible with some copy-protected audio CDs/ DVDs.

<sup>5</sup> For information on compatibility with iPod® and iPhone® models, please contact your Porsche Centre.

– not available   ○ I number/extra-cost option   ● standard equipment   W no-cost option

The vehicles pictured in the chapter on personalisation may include additional options not featured in this catalogue. For information on these options, please consult your Porsche Centre. For information on the options featured in this catalogue, please refer to the price list.

## Porsche Exclusive

### State-of-the-art. And to your specification.

With Porsche Exclusive you can make your Porsche even more special. Direct from the factory.

Individually and exclusively tailored to your wishes. Aesthetically and technically, inside and outside, using high-quality materials and with customary Porsche quality. The principle: tailor-made by craftsmen. You will find a wide range of design options in the separate Porsche Exclusive 911 catalogue.

Either your Porsche Centre or the customer centre in Zuffenhausen (tel. +49 (0)711 911-25332) will be pleased to answer all your enquiries. Please note that delivery times may be extended for certain Porsche Exclusive equipment.



### Porsche Centres

Your Porsche Centre can assist you with every aspect of purchasing and owning your Porsche. You will also find a wide range of products and services, including genuine Porsche parts and accessories.



### Porsche Assistance

Enjoy peace of mind with our exclusive breakdown and accident recovery service. Membership is free when you buy a new Porsche.



### Porsche Financial Services

Our innovative suite of financial services is specially tailored to the needs of Porsche owners. Products range from attractive finance and leasing options to vehicle insurance and the Porsche Card.



### Porsche Exclusive

Realise your vision of the perfect Porsche with our factory customisation programme. From styling enhancements to performance upgrades, all modifications are uniquely handcrafted for your Porsche.



### Porsche Tequipment

Personalise your Porsche at any time after purchase with the Tequipment range of approved accessories. Designed exclusively for your car, every product is fully guaranteed.



### Porsche Design Driver's Selection

With products ranging from fashion and accessories to tailored luggage, this unique collection combines quality and style with everyday practicality.

## Service

### Porsche Used Car Programme

Porsche Approved is the simple way to find the perfect pre-owned Porsche, anywhere in the world. Every car is rigorously tested and comes with a comprehensive vehicle warranty.

### Porsche Classic

Your specialist source for genuine Porsche parts and technical documentation as well as servicing, repair and restoration for all types of classic Porsche. Find out more at [www.porsche.com/classic](http://www.porsche.com/classic).

### Christophorus

Our bi-monthly magazine for Porsche owners has news, interviews and a wide variety of features from throughout the world of Porsche.



### Porsche Online

For all the latest news and information from Porsche, go to [www.porsche.com](http://www.porsche.com).

### Porsche Clubs

Since the first Porsche Club was founded in 1952, their number has grown to 613 with a total of 120,000 members worldwide. To find out more, call +49 (0)711 911-78307 or go to [www.porsche.com](http://www.porsche.com).

### Porsche Driving Experience

**1. Porsche Travel Club.** Exclusive driving holidays and incentive ideas combining luxury and adventure, worldwide. To find out more, call +49 (0)711 911-78155. E-mail: [travel.club@porsche.de](mailto:travel.club@porsche.de)

### 2. Porsche Sport Driving School.

Develop your skill and explore your Porsche with the Porsche Sport Driving School. To learn about events at some of the world's most famous racing venues, call +49 (0)711 911-78683. E-mail: [sportdrivingschool@porsche.de](mailto:sportdrivingschool@porsche.de)



Ask your Porsche Centre for the latest brochures from Porsche Exclusive, Porsche Tequipment, Porsche Design Driver's Selection and the Porsche Driving Experience.



## Summary

**The new 911 Turbo S. The 911 Turbo. In Coupé or Cabriolet form. They are our inventory of what is technically possible. In terms of driving performance. In terms of everyday**

**practicality. In terms of efficiency. And they are the proof that the unique path pioneered in 1974 remains relevant today if instilled with new vigour: Efficiency demands performance. Charged.**

# Technical data

		911 Turbo/911 Turbo Cabriolet	
<b>Engine</b>			
Cylinders		6	
Displacement		3,800 cm <sup>3</sup>	
Power (DIN) at		368 kW (500 hp) 6,000–6,500 rpm	
Max. torque at		650 Nm at 1,950–5,000 rpm with 'overboost' 700 Nm at 2,100–4,000 rpm	
Compression ratio		9.8:1	
<b>Transmission</b>			
Layout		All-wheel drive with electronically controlled multi-plate clutch	
6-speed manual gearbox		Standard	
7-speed PDK		Optional	
<b>Chassis</b>			
Front axle		McPherson strut suspension	
Rear axle		LSA multi-link suspension	
Steering		Variable steering ratio, power-assisted (hydraulic)	
Turning circle		10.9 m	
Brakes		6-piston monobloc aluminium fixed calipers at front, 4-piston monobloc aluminium fixed calipers at rear, discs internally vented and cross-drilled	
Vehicle stability system		Porsche Stability Management (PSM)	
Anti-lock braking system		ABS 8.0	
Wheels	Front	8.5 J x 19 ET 56	
	Rear	11 J x 19 ET 51	
Tyres	Front	235/35 ZR 19	
	Rear	305/30 ZR 19	

Some of the vehicles illustrated in this brochure are fitted with optional equipment which is available at additional cost. All information regarding supplied equipment, appearance, performance, dimensions, weight, fuel consumption and running costs is correct to the best of our knowledge at the time of going to press. Porsche reserves the right to alter specifications and other product information without prior notice.

\* Weight is calculated in accordance with the relevant EC Directives and is valid for vehicles with standard specification only. Optional equipment increases this figure. The figure given includes 68 kg for the driver and 7 kg for luggage.

\*\* Figures for PDK include the optional Sport Chrono Package Turbo with SPORT PLUS button selected.

	911 Turbo	911 Turbo Cabriolet
<b>Weights</b>	Manual gearbox/PDK	Manual gearbox/PDK
Unladen weight (DIN)	1,570 kg/1,595 kg	1,645 kg/1,670 kg
Unladen weight (EC)*	1,645 kg/1,670 kg	1,720 kg/1,745 kg
Permissible gross weight	1,935 kg/1,960 kg	1,995 kg/2,020 kg
<b>Performance</b>	Manual gearbox/PDK	Manual gearbox/PDK
Top speed km/h (mph)	312 (194)/312 (194)	312 (194)/312 (194)
0–100 km/h (0–62 mph)	3.7 secs/3.6 secs (3.4 secs <sup>**)</sup>	3.8 secs/3.7 secs (3.5 secs <sup>**)</sup>
0–160 km/h (0–99 mph)	7.8 secs/7.7 secs (7.4 secs <sup>**)</sup>	8.1 secs/8.0 secs (7.7 secs <sup>**)</sup>
0–200 km/h (0–124 mph)	11.9 secs/11.6 secs (11.3 secs <sup>**)</sup>	12.4 secs/12.1 secs (11.8 secs <sup>**)</sup>
Flexibility 80–120 km/h (50–75 mph) in 5th gear	3.7 secs/–	3.8 secs/–
Acceleration 80–120 km/h (50–75 mph)	–/2.1 secs	–/2.2 secs
<b>Fuel consumption/emissions***</b>	Manual gearbox/PDK	Manual gearbox/PDK
Urban in l/100 km (mpg)	16.5 (17.1)/16.5 (17.1)	16.7 (16.9)/16.7 (16.9)
Extra urban in l/100 km (mpg)	8.3 (34.0)/8.1 (34.9)	8.4 (33.6)/8.2 (34.4)
Combined in l/100 km (mpg)	11.6 (24.4)/11.4 (24.8)	11.7 (24.1)/11.5 (24.6)
CO <sub>2</sub> emissions g/km	272/268	275/270
<b>Dimensions/aerodynamics</b>		
Length	4,450 mm	4,450 mm
Width (incl. exterior mirrors)	1,852 mm (1,952 mm)	1,852 mm (1,952 mm)
Height	1,300 mm	1,300 mm
Wheelbase	2,350 mm	2,350 mm
Luggage compartment volume (VDA)	105 litres	105 litres
Tank capacity	67 litres	67 litres
Drag coefficient	c <sub>w</sub> = 0.31	c <sub>w</sub> = 0.32

\*\*\* Data determined in the NEDC (New European Driving Cycle) in accordance with the Euro 5 (715/2007/EC and 692/2008/EC) measurement method. The figures do not refer to an individual vehicle nor do they constitute part of the offer. They are intended solely as a means of comparing different types of vehicle. You can obtain further information about individual vehicles from your Porsche Centre. Fuel consumption calculated for vehicles with standard specification only. Optional equipment may affect fuel consumption and performance.

911 Turbo S/911 Turbo S Cabriolet		
<b>Engine</b>		
Cylinders	6	
Displacement	3,800 cm <sup>3</sup>	
Power (DIN) at	390 kW (530 hp) 6,250–6,750 rpm	
Max. torque at	700 Nm at 2,100–4,250 rpm	
Compression ratio	9.8:1	
<b>Transmission</b>		
Layout	All-wheel drive with electronically controlled multi-plate clutch	
7-speed PDK	Standard	
<b>Chassis</b>		
Front axle	McPherson strut suspension	
Rear axle	LSA multi-link suspension	
Steering	Variable steering ratio, power-assisted (hydraulic)	
Turning circle	10.9 m	
Brakes	Porsche Ceramic Composite Brake (PCCB): 6-piston monobloc aluminium fixed calipers at front, 4-piston monobloc aluminium fixed calipers at rear, discs internally vented and cross-drilled	
Vehicle stability system	Porsche Stability Management (PSM)	
Anti-lock braking system	ABS 8.0	
Wheels	Front	8.5 J x 19 ET 56
	Rear	11 J x 19 ET 51
Tyres	Front	235/35 ZR 19
	Rear	305/30 ZR 19

	911 Turbo S	911 Turbo S Cabriolet
<b>Weights</b>	PDK	PDK
Unladen weight (DIN)	1,585 kg	1,660 kg
Unladen weight (EC)*	1,660 kg	1,735 kg
Permissible gross weight	1,950 kg	2,010 kg
<b>Performance</b>	PDK	PDK
Top speed km/h (mph)	315 (196)	315 (196)
0–100 km/h (0–62 mph)**	3.3 secs	3.4 secs
0–160 km/h (0–99 mph)**	7.1 secs	7.4 secs
0–200 km/h (0–124 mph)**	10.8 secs	11.3 secs
Acceleration 80–120 km/h (50–75 mph)	2.0 secs	2.1 secs
<b>Fuel consumption/emissions***</b>	PDK	PDK
Urban in l/100 km (mpg)	16.5 (17.1)	16.7 (16.9)
Extra urban in l/100 km (mpg)	8.1 (34.9)	8.2 (34.4)
Combined in l/100 km (mpg)	11.4 (24.8)	11.5 (24.6)
CO <sub>2</sub> emissions g/km	268	270
<b>Dimensions/aerodynamics</b>		
Length	4,450 mm	4,450 mm
Width (incl. exterior mirrors)	1,852 mm (1,952 mm)	1,852 mm (1,952 mm)
Height	1,300 mm	1,300 mm
Wheelbase	2,350 mm	2,350 mm
Luggage compartment volume (VDA)	105 litres	105 litres
Tank capacity	67 litres	67 litres
Drag coefficient	c <sub>w</sub> = 0.31	c <sub>w</sub> = 0.32

Some of the vehicles illustrated in this brochure are fitted with optional equipment which is available at additional cost. All information regarding supplied equipment, appearance, performance, dimensions, weight, fuel consumption and running costs is correct to the best of our knowledge at the time of going to press. Porsche reserves the right to alter specifications and other product information without prior notice.

\* Weight is calculated in accordance with the relevant EC Directives and is valid for vehicles with standard specification only. Optional equipment increases this figure. The figure given includes 68 kg for the driver and 7 kg for luggage.

\*\* Values with SPORT PLUS button selected.

\*\*\* Data determined in the NEDC (New European Driving Cycle) in accordance with the Euro 5 (715/2007/EC and 692/2008/EC) measurement method. The figures do not refer to an individual vehicle nor do they constitute part of the offer. They are intended solely as a means of comparing different types of vehicle. You can obtain further information about individual vehicles from your Porsche Centre. Fuel consumption calculated for vehicles with standard specification only. Optional equipment may affect fuel consumption and performance.



## Index

Option	Page								
<b>A</b>		<b>D</b>		<b>G</b>		<b>M</b>		<b>T</b>	
Air conditioning	81	Design	16	Glass rear screen	24	Manual gearbox	46	Porsche Side Impact Protection System (POSIP)	72
Airbags	71	Direct fuel injection (DFI)	32	GPS navigation system	86	Model range	18	Porsche Stability Management (PSM)	56
All-wheel drive	48	Dry-sump lubrication	33			MP3	88	Porsche Torque Vectoring (PTV)	50
Aluminium Look	101	Dynamic cornering lights	65	<b>H</b>		Multifunction steering wheel	44	Porsche Traction Management (PTM)	48
Anti-theft protection	84	Dynamic engine mount system	60	Hardtop	25, 99			Power and performance	110, 112
Audio interface	88			Headlight cleaning system	64	<b>N</b>		Power steering	54
Audio system	86	<b>E</b>		Headlights	64	Navigation	86		
Axle concept	52	Electronic engine management	38	HomeLink® (garage door opener)	84	<b>O</b>		<b>R</b>	
		Engine	30	Hood	24	Oil supply	33	Radio	86
<b>B</b>		Engine management	38			On-board computer	81	Recycling	76
Bodyshell structure	70	Environment	74	<b>I</b>				Roll-over protection	72
BOSE® Surround Sound System	88	Exhaust emission control	75	I numbers	98	<b>P</b>		Roof transport system	84
Brakes	66	Exhaust gas turbocharging	36	Ignition	39	ParkAssist	85		
		Exhaust system	41	Instruments	81	Personalisation	90	<b>S</b>	
<b>C</b>		Expansion intake manifold	40	Interior	80	Porsche Active Suspension Management (PASM)	53	Safety	64
Cabriolet	22	Exterior	16	<b>L</b>		Porsche Ceramic Composite Brake (PCCB)	68	Seats	82
Carbon	101	Exterior mirrors	84	Launch Control	59	Porsche Communication Management (PCM)	86	Servicing	41
CD/DVD autochanger	86			Lighting	65	Porsche Doppelkupplung (PDK)	42	SPORT button	58
Ceramic brake	68	<b>F</b>		Lighting system	64			Sport Chrono Package Turbo	58
Chassis	52	Factory collection	97	Lightweight design	34			Steering	54
Child seats	83	Fuel system	76	Luggage compartment	84			Steering wheels	44
Colours, exterior	92								
Colours, hood	93								
Cruise control	85								



